

CONQUEST V6

OWNER'S MANUAL North America



1-6x24

3-18x50

5-30x50

This product may be covered by one or more of the following United States patents: US6542302, US6816310, US6906862

For further United States patents which may cover this product see:
www.zeiss.com/sports-optics/us/patents

Carl Zeiss Sports Optics North America

Carl Zeiss SBE, LLC
Consumer Optics Business
Group Sports Optics Division
1 Zeiss Drive
Thornwood, NY 10594

www.zeiss.com/us/sports-optics

PRECISION RIFLESCOPES FOR YOUR HUNTING AND SHOOTING ADVENTURES

TABLE OF CONTENTS

Conquest V6 Anatomy: 3-18x50 and 5-30x50 Models	3
Conquest V6 Anatomy: 1-6x24 Model	4
Power Zoom/Magnification Adjustment	5
Focusing the Reticle	5
Reticle Illumination	6
Parallax Adjustment	6
Battery Replacement	7
Riflescope Installation	7
Leveling the Reticle	9
Establishing a Sight-In Zero	9
Elevation Turrets (External): 3-18x50 and 5-30x50 Models	11
Windage Turrets (Capped and External): 3-18x50 and 5-30x50 Models	13
Elevation Turret (External): 1-6x24 Model	15
Elevation and Windage Turret (Capped): 1-6x24 Model	17
Reticles (Second Focal Plane)	18
Conquest V6 Schematic and Power Throw Lever	19
Caring for Your Riflescope	20
Warranty	21
No-Fault Policy and Product Returns	22
Conquest V6 Specifications	23

! WARNING!

Always make sure that your rifle is unloaded prior to mounting or dismounting your riflescope.

ZEISS Sports Optics is not responsible for typographical errors. Product images are for illustration purposes only. Specifications and products may change without prior written notice. All efforts have been made to make sure content is accurate at time of printing.

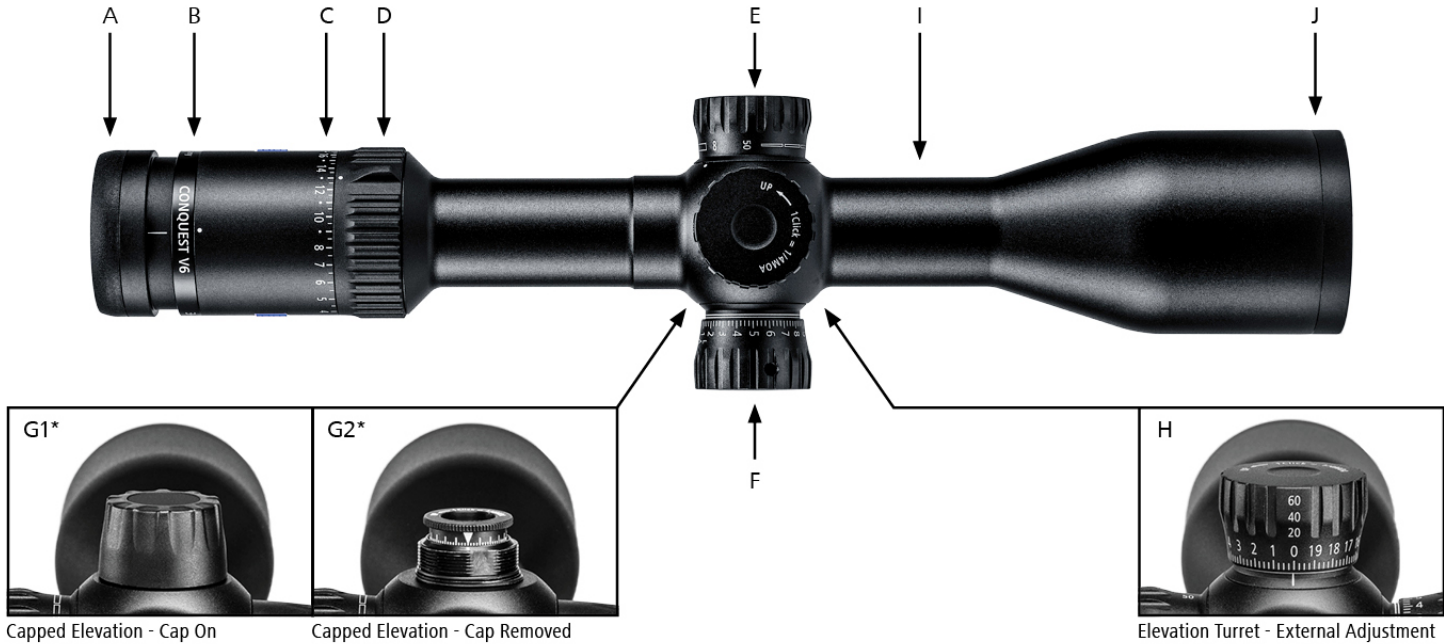

CONQUEST V6 ANATOMY

3-18x50 and 5-30x50

- A: European-Style Fast Focus Eyepiece
- B: Ocular Housing
- C: Power/Magnification Zoom Indicator
- D: Power Zoom Adjustment

- E: Parallax Adjustment
- F: Windage Turret - External
- G1*: Elevation Turret - Capped
- G2*: Elevation Adjustment - Cap Removed

- H: Elevation Turret - External, with Ballistic Stop
- I: Main Tube - 30mm
- J: Objective

**Applicable to 3-18x50 model.*

Features may vary, depending upon model configurations.

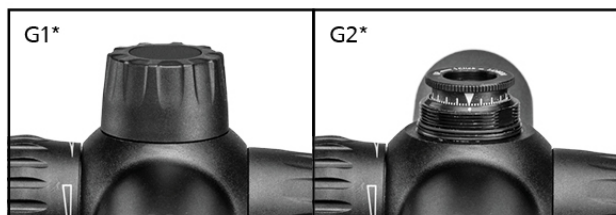
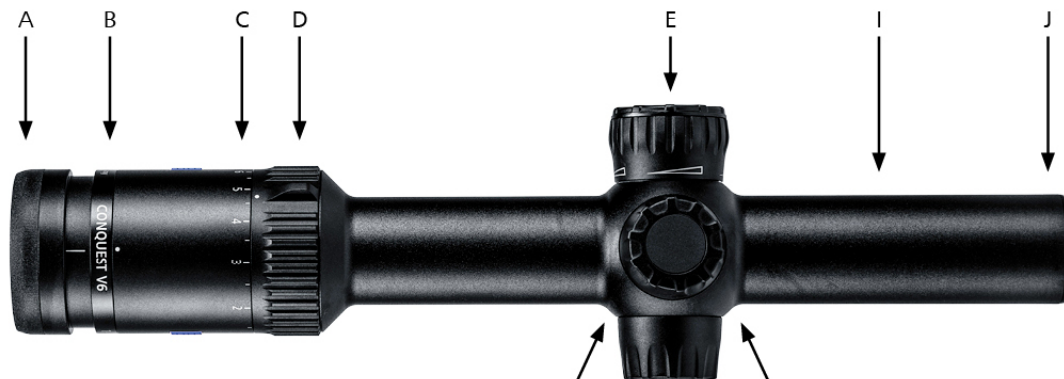

G1* Capped Elevation - Cap On

G2* Capped Elevation - Cap Removed



H Elevation Turret - External Adjustment

CONQUEST V6 ANATOMY

1-6x24

A: European-Style Fast Focus Eyepiece
 B: Ocular Housing
 C: Power/Magnification Zoom Indicator
 D: Power Zoom Adjustment

E: Reticle's Digital Illumination Control
 F: Windage Turret - Capped
 G1*: Elevation Turret - Capped
 G2*: Elevation Adjustment - Cap Removed

H: Elevation Turret - External, Single Turn, Locking, with Ballistic Stop
 I: Main Tube - 30mm
 J: Objective



! WARNING!

Do **NOT** look directly at the sun or other bright lights through the rifle scope. Doing so may cause eye damage or blindness.

POWER ZOOM/MAGNIFICATION ADJUSTMENT

The power zoom adjustment allows for the shooter to select the desired magnification setting. The shooter can accomplish this task by rotating the adjustment while referencing the power zoom indicator scale, located on the ocular housing, and while referencing the power zoom adjustment alignment indicator. (See Image 1a.) This is a frictional adjustment, and it is designed to incorporate felt resistance during adjustment. Therefore, it should remain in position until the shooter adjusts it further.

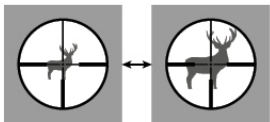

1a. Lower magnification setting with more field of view; higher magnification setting with less field of view

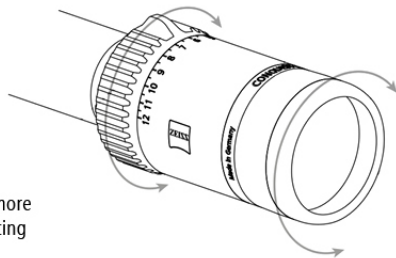

1b. European-style fast focus eyepiece

FOCUSING THE RETICLE

The diopter adjustment and the parallax adjustment aid in creating a better sight image and aiming point. The reticle image should be clear, crisp, and in focus. The European-style fast focus eyepiece is the diopter adjustment, and it is used for establishing the reticle's focus to match your particular vision/corrected vision. If you plan to wear corrective vision glasses when shooting, then set this focus while wearing your corrective glasses or using contact lenses. The reticle focus should be established before setting the parallax adjustment. If the diopter adjustment is set to the extreme position of travel, it can negatively affect parallax. Once set, this setting is good for the season and should then be checked from time to time. **Note: ZEISS recommends initially setting the diopter adjustment to neutral/zero setting and adjusting from this position if necessary.**

Reticle Focus Adjustment

In order to adjust the European-style fast focus eyepiece to establish an appropriate diopter setting, simply turn the eyepiece either inward or outward to achieve the preferred setting. (See Image 1b.)

1. Begin at the highest magnification setting.
2. Set parallax to the infinity setting ∞ . (Dependent upon model.)
3. Look through the rifle scope at a neutral colored background, such as a white or gray wall, or cover the objective lens with a light cloth to eliminate distracting background. Determine if the reticle is clear and in focus as soon as you view through the eyepiece. Note that staring at the reticle for more than about two seconds during this setup will cause your eye to begin to compensate for focus, resulting in a false indication of the reticle's true

focus. Try to assess a few seconds at a time, looking away for about 5-10 seconds, and then view again to determine results. Your goal is to view a crisp and highly focused reticle image – without straining your eye.

4. If adjustment is necessary, follow these steps: Because of the way your eye focuses, ideal results are typically obtained by turning the eyepiece inward until the reticle is slightly blurred, then moving it outward until sharp focus is obtained. (See Image 2a.)

Once you are satisfied with the reticle's focus, note the position of the eyepiece for quick reference in the future.

PLEASE NOTE: While using the rifle scope, if the reticle tends to go in and out of focus or eye strain is present with shooting sessions, this is an indicator that the reticle needs to be focused/refocused for your eye.

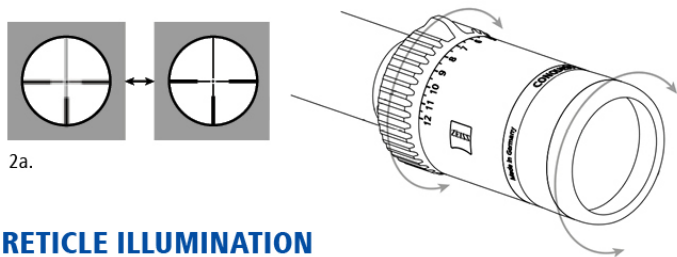

RETICLE ILLUMINATION

Select ZEISS Conquest V6 riflescopes feature the digital illumination option for the reticle. The reticle's digital illumination control allows for adjustment of the intensity of the illumination. The digital angle sensor further controls the illumination, via auto on/off feature while rifle is in use.

Reticle's Illumination On/Off Settings (Located on Reticle's Illumination Control/Adjustment)

To illuminate the reticle, pull out on the reticle control/adjustment. The reticle will default to the intensity setting used previously. To turn off the illuminated reticle, press in on the illumination control/adjustment until you feel a distinct click, indicating the off setting has been achieved. *After three hours of inactivity of the rifle scope, the reticle will automatically turn off.*

Reticle Illumination Intensity Adjustment

While the reticle is switched on, you can rotate the illumination control to adjust the intensity of the reticle's illumination to your preferred setting. Rotating the control toward the muzzle will decrease the intensity setting. Rotating the control toward the shooter will increase the intensity setting.

PARALLAX ADJUSTMENT

Select ZEISS Conquest V6 riflescopes incorporate a side parallax adjustment, and the adjustment range is from 50 yards to infinity. Conquest V6 models that do not offer this feature have a fixed parallax setting of 100 yards.

Parallax is the apparent movement of the reticle in relation to the target as the shooter moves his eye across the exit pupil of the rifle scope. This condition is caused by the target and the reticle appearing on different focal planes within the rifle scope. (See supporting imagery below.)



Distance about 100 yards: Image and reticle are located in a single plane (parallax absent).



Distance about 300 yards: Image behind the reticle (parallax present).

The goal is to remove the parallax sighting error by adjusting the focus settings via the parallax adjustment.

When parallax is present while shooting at longer distances and at higher magnification settings, it can easily result in relevant sighting errors. For the most accurate and best shooting results, the shooter should constantly check for parallax and remove it when necessary via the side parallax adjustment, especially when shooting at targets at varying distances.

Adjusting to Remove Parallax

Check for parallax with the rifle in a stable position and while looking through the riflescope at a defined point on the target. If parallax is present, while moving your head up and down, you will witness it. When parallax is present, the reticle will appear to move slightly up and down, even though the rifle and riflescope are stationary. If the reticle remains stable across the defined point of aim, while moving your head up and down while looking through the riflescope, then parallax has been removed.

To eliminate parallax, rotate the parallax adjustment until the reticle remains stable in relation to the target, regardless of head movement.

BATTERY REPLACEMENT

The battery is located below the reticle's illumination control cap. It is removed by turning the knurled cap counterclockwise. ZEISS suggests replacing the battery in a controlled environment in order to reduce contamination to the battery compartment and ensure you more easily maintain control of the cap.

In regard to reticle illumination, a fresh battery has an estimated run time of over 700 hours when set at the lowest intensity level. Replace depleted

batteries with a quality CR2032 battery or equivalent. Install the battery with the positive (+) side up. To help prevent premature battery discharge, the auto off feature will engage due to the rifle's angle, position, or inactivity of the rifle.

Battery run times can be adversely impacted by colder temperatures.

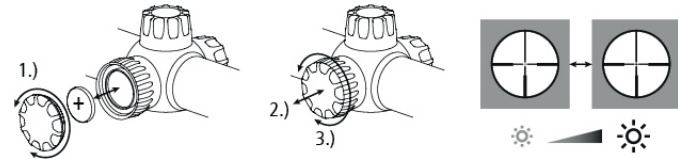

- 1) Unscrew cap and replace battery.
- 2) Screw on cap and pull out on the reticle control/adjustment.
- 3) Adjust to control intensity.



! WARNING!

STOP! Make sure your rifle is unloaded, the chamber is empty, and the action is open prior to installing your ZEISS riflescope.

RIFLESCOPE INSTALLATION

POOR OR IMPROPER MOUNTING OF THE RIFLESCOPE CAN CAUSE EQUIPMENT AND/OR PERSONAL DAMAGE, WHICH CAN RESULT IN SERIOUS EQUIPMENT DAMAGES, AS WELL AS PERSONAL INJURY OR DEATH.

ZEISS strongly recommends that you use high quality mounting solutions that appropriately fit the riflescope model. Follow the manufacturer's torque specifications for successful mounting of rings, bases and mounting solutions.

Ring and Base Selection (Rings Equal 30 mm)

To optimize the performance of the riflescope and mounting solutions, ZEISS recommends the following:

- Use a high-quality ring and base combination that properly fits the rifle as well as the riflescope model.

! WARNING!

Recoil is real energy, and it can be dangerous for the shooter! Please be certain that your installation provides maximum eye relief. Pay attention to this warning, especially when shooting uphill and/or from a prone position. Shooting conditions such as these can dramatically reduce eye relief. PLEASE MAINTAIN MAXIMUM EYE RELIEF!

Mounting the Base to the Action

Attach the base to the action, and follow the torque setting for the mounting screws provided by the manufacturer. Ensure the mounting screws and threaded holes are clean and free of grease and contaminants.

Mounting the Rings to the Base

Ensure that the inside surfaces of the rings and the surface of scope tube are clean and free of grease.

Ensure that the height of the rings will allow for adequate clearance of the objective and barrel surface. If you plan to use flip-up or pull-over lens covers, consider the additional space requirements for those at this time. Install the rings on the base per the manufacturer's specifications. Take care to position the rings where they will not make contact with the turret assembly body, the objective bell-to-tube transition point, or the power zoom adjustment transition point.

Ensure that the riflescope lies into the rings stress-free. Damage to the riflescope or riflescope's finish resulting from improper alignment, lapping, and installation is not covered by the warranty.

Mounting the Riflescope

1. For initial fit of the riflescope to the rifle, set the riflescope to the highest magnification. Place the riflescope in the rings as far forward as possible. Tighten the ring screws with minimal tension to gently but safely hold the riflescope where positioned. This initial step should just allow the scope to move back and forth for Step 2 listed below
2. Place the rifle in your normal shooting position. Place your head as far forward on the stock as you might position it in field use. Slowly move the riflescope back just to the point where the full field of view is obtained. ZEISS recommends mounting the riflescope at this position to **ensure maximum eye relief.**

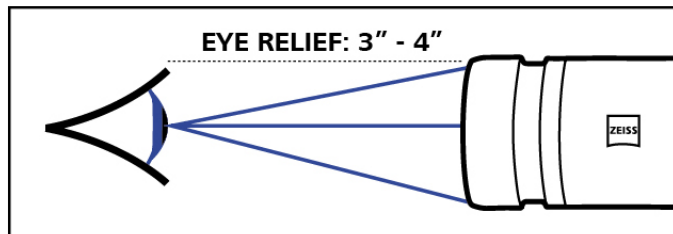

Note: While wearing thick clothing, you may need to adjust your riflescope mounting location to accommodate for maximum eye relief.

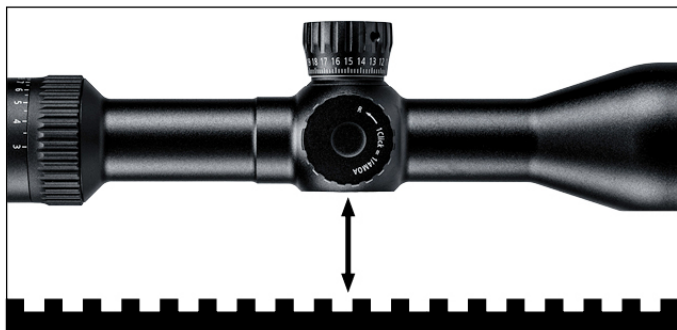

These two surfaces should be parallel to each other.

LEVELING THE RETICLE

For precise shot placement, the reticle and the rifle need to be squared, or plumb, to each other. This will reduce sighting errors that will be magnified as distance to target is increased.

The reticles in ZEISS riflescopes are plumb with the flat surface on the bottom of the riflescope. To level the reticle using a plumb line, follow these helpful steps:

1. Ensure the rifle is unloaded and is level and affixed in a steady rest or sandbags throughout this procedure.
2. While viewing through the riflescope, reference a plumb line or plumb target frame at a suggested distance of approximately 100 yards.

3. From the shooting position, center/align the reticle on the plumb line for reference, and rotate the riflescope in the rings until the vertical line of the reticle is parallel with the plumb reference line. Be patient with this process, and double check the rifle's position. Rotate the riflescope as needed to align the reticle with the plumb line.

When all is adjusted and aligned properly, finalize the tightening of the ring screws evenly to secure the riflescope in the rings.

Torque the ring screws to the recommended torque settings. Your ZEISS riflescope should now be mounted and secured in the proper position.

ESTABLISHING A SIGHT-IN ZERO

NOTE: The elevation and windage turrets' adjustment settings are set at the halfway position of the riflescope's total adjustment value available, from the factory. To access the total adjustment travel value, the elevation turret's Ballistic Stop must be loosened to further maximize total travel adjustment available.

Please visit www.zeiss.com/us/sports-optics for a video tutorial on this process and setting methods that can maximize the performance of your Ballistic Stop configured riflescope.

In order to save time and ammunition and achieve proper results with the least amount of effort, ZEISS suggests you have the riflescope bore sighted by an appropriate gunsmith or service center that deals in riflescope mounting. You can also accomplish this task by looking down the barrel's bore at a high contrast target, approximately 6" in diameter. The target can be mounted at

a distance of 25, 50, or 100 yards for the best solution. The selected target should be easy to see from any of these distances. While the target may be only 6" in diameter, ZEISS recommends using a white paper backer of at least 24" x 24" in size. This will allow you to visualize and plot your shot placement with ease.

1. Confirm that the rifle is unloaded and the chamber is empty. Affix the rifle in a steady rest, and remove the bolt assembly.
2. While looking down the bore's centerline, from the action end, (A1) center the target in the bore. The target should appear in the center of the barrel's bore. (A2) With rifle held in position, not allowing it to move, adjust the elevation and windage turrets until the reticle is centered on the target (A3), keeping the target centered in the bore during this process. **NOTE: At this time, if you feel you have run out of elevation adjustment, refer to the next section covering the Ballistic Stop Turret to see how to access further elevation adjustment/range of travel.**
3. With the bore sighting process completed, you can begin live firing sight-in at the respective 25, 50, or 100 yards. ZEISS recommends two or three confirmation shots. After confirming your point of impact, proceed to the next step.

PLEASE NOTE: Because MOA is an angular unit of measure, if you have sighted in at 25 yards, while referencing .25 MOA adjustments, you will need to adjust the travel four times more than you would with a 100-yard sight-in. Also, if you sighted in at 50 yards, while referencing .25 MOA adjustments, you will need to adjust the travel two times more than you would with a 100-yard sight-in. If you are sighting in at 100 yds, and the

first shot is not on the target backer paper, ZEISS suggests you move to a 25-yard sighting distance.

4. It is now time to aim the rifle and center the reticle on the intended sight-in target from step 3. While holding the rifle steady on the center of the target and ensuring it doesn't move, while looking through the riflescope, adjust the elevation and windage turrets until the reticle is aligned in the center of the 2-3 shot group from step 3. If you have run out of elevation adjustment/travel, refer to the next section covering the Ballistic Stop Turret to see how to access further adjustment/range of travel.
5. ZEISS suggests you shoot a three-shot group at the sight-in target/close-range zero distance. When this is accomplished, allow the barrel to cool, and then fine tune the riflescope's zero with final elevation and windage adjustment corrections, to your preferred target distance. Confirm your preferred and final zero and zero sight-in distance with another three-shot group.

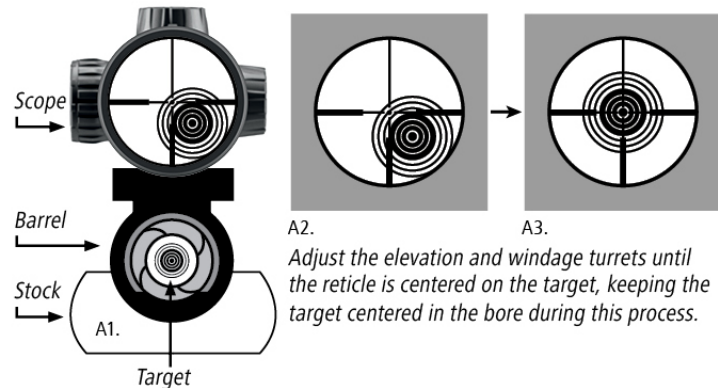

A2.

A3.

Adjust the elevation and windage turrets until the reticle is centered on the target, keeping the target centered in the bore during this process.

ELEVATION TURRETS (EXTERNAL): 3-18x50 AND 5-30x50 MODELS

Some of the Conquest V6 riflescope models incorporate an external, non-locking, multi-turn elevation turret, with a Ballistic Stop feature. The turret's multi-turn design allows for the maximum use of the riflescope's elevation travel above your established zero. This further allows for greater elevation adjustment range that supports target engagement at longer distances. **The ZEISS Ballistic Stop** allows for a definitive stop when the turret is returned to zero.

Note: The O-rings underneath the turret assembly must be clean and free of defects and debris. While setting and adjusting the Ballistic Stop, please ensure that these mechanical components remain free of dirt and contaminants. If you are satisfied with your ammunition selection and zero/sight-in, follow these instructions to finalize the setting of the Ballistic Stop feature:

1. Remove the elevation turret cap by **loosening** the two set screws; however, **do not remove the screw(s) entirely**. The cap can now be lifted off of the turret assembly. (See Image 1.)
2. You may feel slight resistance while lifting off the cap. You should **NOT** feel any clicks at this time; if you do, the turret cap set screws should be loosened further. Place the turret cap aside on a clean surface. Take care to keep the inside of the turret cap clean and free of debris. (See Image 2.)
3. The Ballistic Stop assembly is now exposed. Maintain the cleanliness of the Ballistic Stop assembly. (See Image 3.)
4. Loosen – but do NOT remove – each of the set screws on the Ballistic Stop barrel assembly. (See Images 4a, 4b, and 4c.) Note the cam at the bottom of the barrel stem assembly. Note the stop step at the top of the turret's base assembly. When these two surfaces engage, this establishes the firm stop position of the Ballistic Stop.

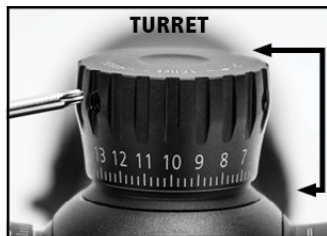

1. Loosen the set screws.



2. Place the turret aside on a clean surface.



3. Internal turret assembly.



4a. Ballistic Stop screws (x2).

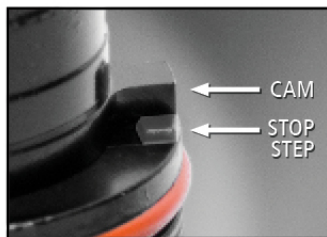

4b. Cam and stop step engaged, establishing firm stop position of Ballistic Stop.



4c. Barrel assembly with cam.

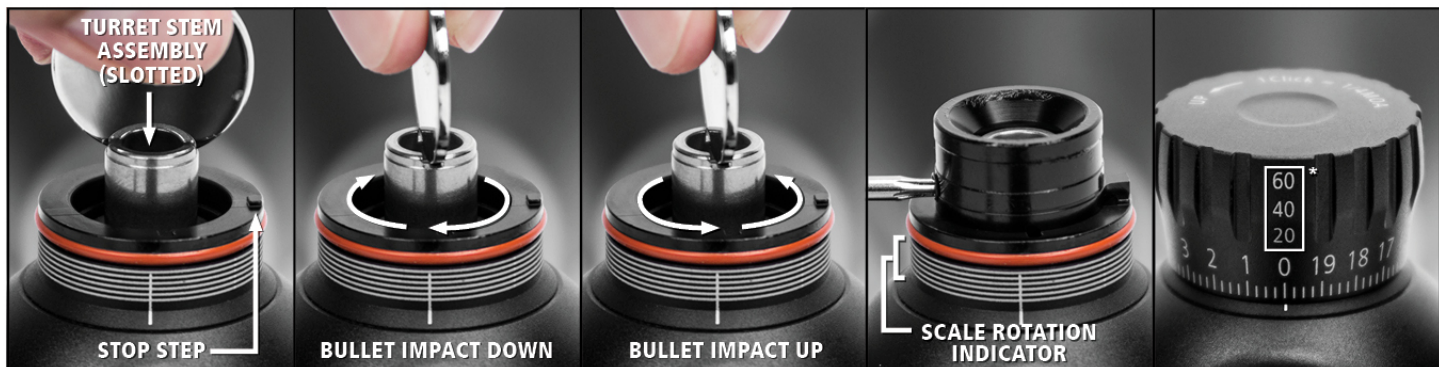

5a. Rotate the slotted portion of the turret stem assembly either downward or upward to your selected zero position.

5. With the Ballistic Stop barrel assembly loosened, remove it and rotate the slotted portion of the turret stem assembly either downward or upward to your selected zero position. (See Image 5a.) Once your desired sight-in zero is achieved, reinstall the Ballistic Stop barrel assembly. (See Image 5b.) Rotate it clockwise (from the shooter's position) until the cam contacts the stop step (See Image 4b, for proper positioning of the Ballistic Stop cam and stop step.) Tighten the set screws while holding the barrel assembly in place.

6. While holding the Ballistic Stop barrel assembly mechanism in proper position, tighten the two T8 set screws to ~5.3 in-lbs. Do NOT over tighten the screws. If you do not have a calibrated torque driver, ZEISS suggests you hold the short end of the provided Torx™ wrench between your thumb and finger and turn the Torx™ wrench approximately 1/8 - 1/4 turn past initial resistance to obtain a secure position setting. Improper torque settings can cause the Ballistic Stop to slip during turret adjustment.

5b. Reinstall the barrel assembly.

7. Check to be sure the entire assembly is clean and free of debris, replace the turret, center it over the turret body assembly, and press down lightly into position. Maintain slight downward pressure on the cap, align the cap's engraved numerical "0"/zero index mark with the vertical engraved center line on the turret's base housing, and tighten both T8 set screws to ~5.3 in-lbs. If you do not have a calibrated torque driver, ZEISS suggests you hold the short end of the provided Torx™ wrench between your thumb and finger and turn the Torx™ wrench approximately 1/8 - 1/4 turn past initial resistance to obtain a secure position setting. Improper torque settings can cause the turret's cap to slip during turret adjustment.

7. Reinstall the turret aligning the turret's engraved numerical zero with the vertical center line.

**(20, 40, 60 from Image 7 above are turret rotation indicators.
20 = 20 MOA/one rotation; 40 = 40 MOA/two rotations;
60 = 60 MOA/three rotations).*

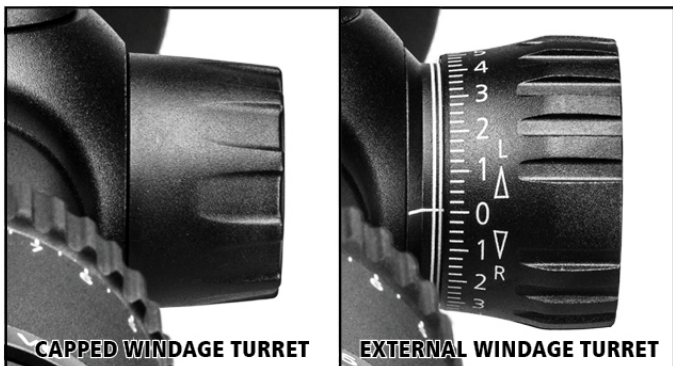

WINDAGE TURRETS (CAPPED AND EXTERNAL): 3-18x50 AND 5-30x50 MODELS

The windage turrets on Conquest V6 riflescopes vary in configuration. ZEISS offers two variations: a capped windage turret and an external windage turret, depending on the model selected. The capped windage adjustment is waterproof, even with the caps removed, and can be used without the cap installed. See illustrating images above to identify capped vs. external windage turrets.

1a. Regarding the capped windage turret adjustment, remove the protective cap by rotating it in a counterclockwise direction.

1b. With the cap removed, the windage turret is now accessible and can be adjusted in either direction for appropriate sight-in correction for both left and right sighting corrections.

Continued on following page.

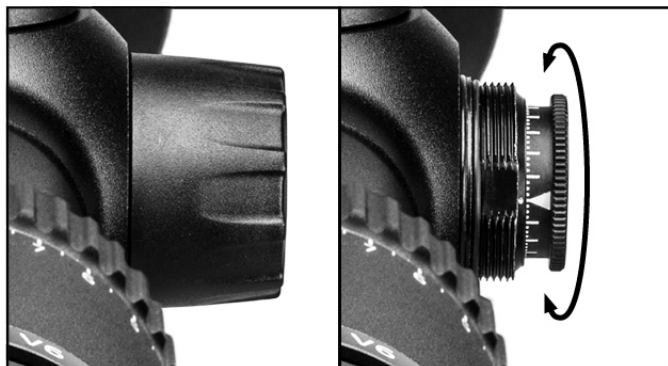

1a. Rotate in a counterclockwise direction to remove the protective cap. 1b. Exposed windage turret. Rotate left or right to adjust for sight-in correction.

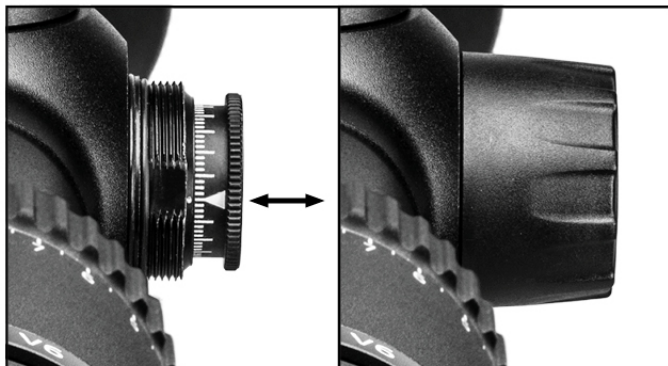

1c. Pull out the windage turret's outer ring and freely rotate it to index the zero position. Release the turret's outer ring. 1d. Replace the windage turret's cap.

1c. Once your sight-in is established, re-index to the turret's numerical "0"/zero setting by simply pulling out the windage turret's outer ring and freely rotating it to index the zero position. You should not feel any clicks when pulling out and rotating the windage turret's outer ring to the indexed "0"/zero position.

1d. Replace the windage turret's cap.

2a. Regarding the external windage turret adjustment, this configuration provides immediate access to the windage turret's adjustment value.

2b. Adjust the turret in either direction for appropriate sight-in correction for both left and right sighting corrections.

2c. Once your sight-in is established, re-index to the turret's numerical "0"/zero setting by loosening – but not removing – the turret's two set screws and freely rotating the turret to index the "0"/zero position.

2d. With the two set screws loosened properly, you should not feel any clicks when rotating the windage turret to the indexed "0"/zero position. While holding the windage turret in place, tighten the two T8 set screws with the provided Torx™ wrench, and torque them to ~5.3 in-lbs.

If you do not have a calibrated torque driver, ZEISS suggests you hold the short end of the provided Torx™ wrench between your thumb and finger and turn the Torx™ wrench approximately 1/8 - 1/4 turn past initial resistance to obtain a secure position setting. **Improper torque settings can cause the turret's cap to slip during turret adjustment.**

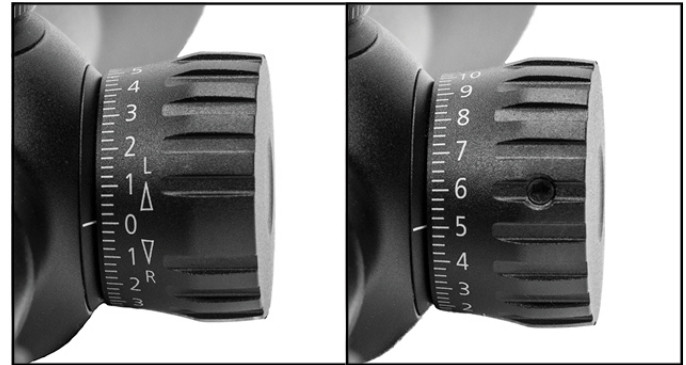

2a. External windage turret adjustment

2b. Rotate left or right for appropriate sight-in correction.

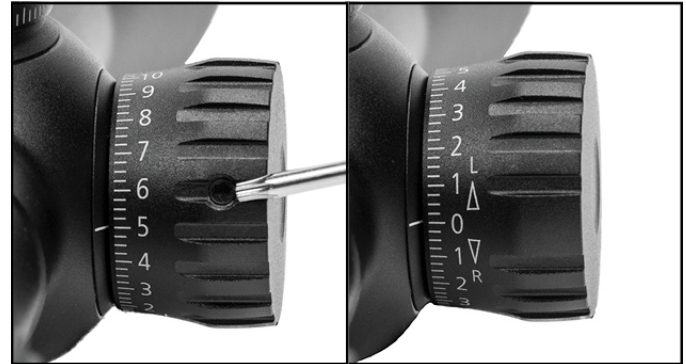

2c. Loosen the two set screws.
DO NOT REMOVE.

2d. Freely rotate the loosened windage turret to index at zero, and tighten the two set screws.

ELEVATION TURRET (EXTERNAL): 1-6x24 MODEL

Setting the External Elevation Turret's Ballistic Stop

The elevation turret for the Conquest V6 1-6x24 models specifically incorporates the following: an external, lift-to-turn, single turn, locking, Ballistic Stop turret design.

NOTE: The elevation and windage turrets' adjustment settings are set at the halfway position of the total adjustment value available, from the factory.

To access the total adjustment travel value available, the elevation turret's Ballistic Stop must be accessed and repositioned.

1a. In order to adjust the elevation turret to establish your zero, lift up on the turret, and then adjust to your preferred zero setting.

2a. If you determine that your sight-in adjustment requires further access to the total elevation travel value, completely loosen the turret's top Torx™ screw.

2b. Remove the turret from the turret housing, set the turret aside, and keep it clean.

2c. Note the Ballistic Stop's position, **taking note of the turret's base vertical pin vs. barrel assembly vertical pin settings.**

2d. Lift and rotate the Ballistic Stop barrel assembly to where the assembly's vertical stop pin is located on the opposite side of the turret's base vertical stop pin.

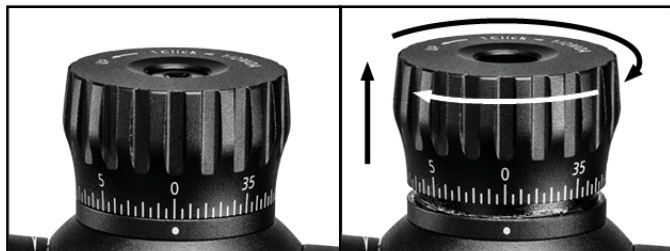

1. Lift and rotate the elevation turret to establish your preferred zero setting.

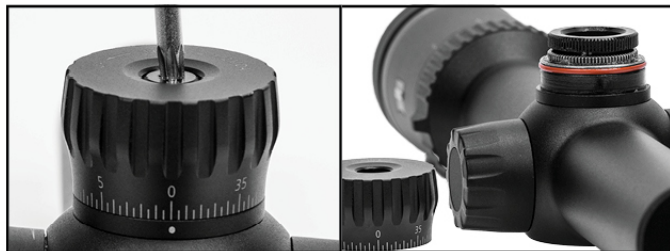

2a. Loosen the turret's top torx™ screw.

2b. Lift the turret from the turret housing and set it aside.

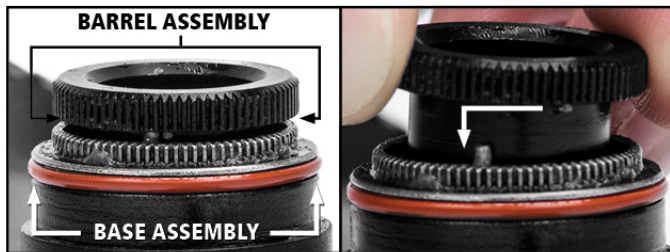

2c. Vertical stop pins engaged.

2d. Position the barrel assembly's pin on the left side of the base assembly's pin.

2e. Replace the turret cap, press it down to the locked position, and retighten. With the Ballistic Stop repositioned, you can continue to adjust the elevation turret for the sight-in process. Repeat these steps, if necessary, to continue the sight-in process.

2f. After confirming your final sight-in and live-fire zero, you are ready to set the Ballistic Stop.

2g. Now that you have an established zero, ensure the elevation turret is pressed downward, in the locked position, in order to keep it from rotating, while completely loosening the elevation turret's top Torx™ set screw. Remove the elevation turret, and set it aside on a clean surface.

3a. Lift and rotate the Ballistic Stop barrel assembly to where the assembly's vertical stop pin is positioned properly against the turret's base vertical stop pin.

3b. Replace the turret cap, align it to the zero position, press it downward to the locked position, and retighten the elevation turret's top set screw to 5.3 - 6.0 in.-lbs. (Ensure the elevation turret is in the down/locked position to allow for proper tightening of the elevation turret's top set screws.)

If you do not have a calibrated torque driver, ZEISS suggests you use the provided Torx™ wrench to turn the set screw to approximately 1/8 - 1/4 turn past initial resistance obtain a secure position setting. **Improper or insufficient torque settings can cause the turret itself to slip while trying to adjust the turret afterwards.**

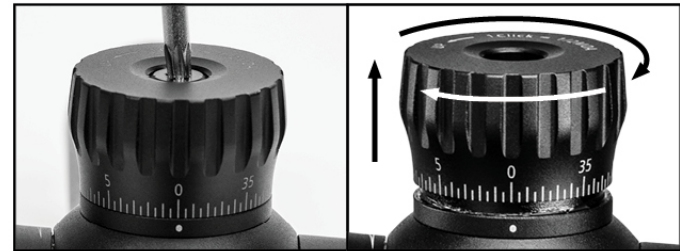

2e. Retighten the turret's top slotted screw. 2f. Continue your sight-in to zero.



2g. Loosen the turret's top slotted screw. 3a. Position assembly's vertical stop pin against the turret's base vertical stop pin.



VERTICAL STOP PINS ENGAGED

3b. Retighten the turret's top slotted screw.

ELEVATION AND WINDAGE TURRET (CAPPED): 1-6x24 MODEL

1. In regard to the capped elevation turret adjustment, remove the protective cap by rotating it in a counterclockwise direction.
2. With the cap removed, the elevation turret is now accessible, and you can adjust the turret in either direction for appropriate sight-in correction for both up and down sighting corrections.
3. Once your sight-in is established, re-index to the turret's numerical "0"/zero setting by simply lifting the elevation turret's outer ring and freely rotating it to index the zero position. You should not feel any clicks when lifting and rotating the elevation turret's outer ring to the indexed "0"/zero position. You can now replace the elevation turret's cap.
4. In regard to the capped windage turret adjustment, remove the protective cap by rotating it in a counterclockwise direction.
5. With the cap removed, the windage turret is now accessible, and you can adjust the turret in either direction for appropriate sight-in correction for both left and right sighting corrections.
6. Once your sight-in is established, re-index to the turret's numerical "0"/zero setting by simply lifting the windage turret's outer ring and freely rotating it to index the zero position. You should not feel any clicks when lifting and rotating the windage turret's outer ring to the indexed "0"/zero position. You can now replace the windage turret's cap.

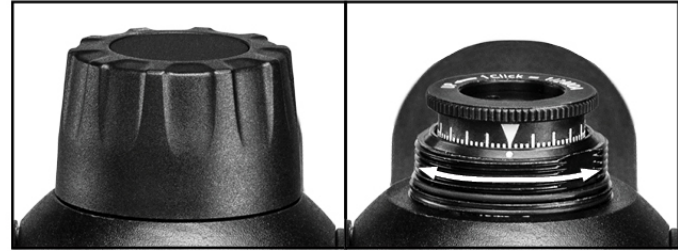

1. Rotate counterclockwise to remove cap.
2. Adjust left or right for appropriate up and down sight-in correction.

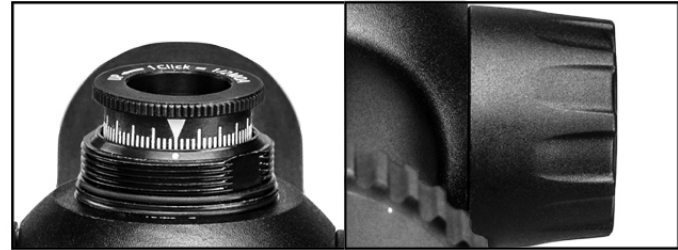

3. Lift the elevation turret's outer ring and freely rotate it to index the zero position.
4. Rotate counterclockwise to remove cap.

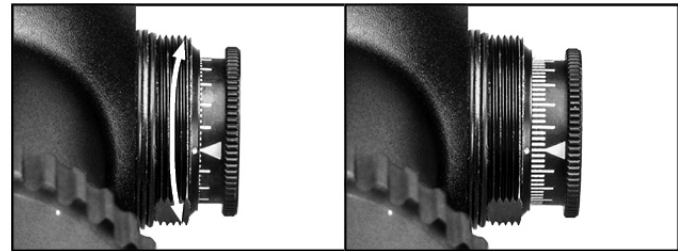

5. Adjust left or right for appropriate sight-in correction.
6. Lift the elevation turret's outer ring to freely rotate it to index the zero position.

RETICLES (SECOND FOCAL PLANE)

Long-Range Hunting and Shooting Reticles

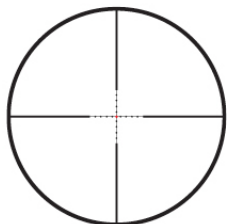

Reticle #43

Mil-Dot, Non-Illuminated
(Subtension at 30x, for 5-30x50)

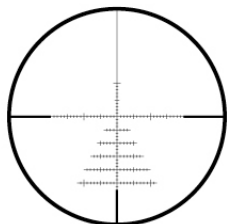

Reticle ZBR

MOA-based, Smart Design, with
Windage References, Non-Illuminated

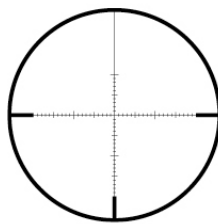

Reticle ZMOA

MOA-based, Smart Design,
Non-Illuminated

ZBR-1 (5-30x50)

Hash marks indicate ONE MOA spacing @ 25x

ZBR-2 (3-18x50)

Hash marks indicate TWO MOA spacing @ 18x

ZMOA-1 (5-30x50)

Hash marks indicate ONE MOA spacing @ 25x

ZMOA-2 (3-18x50)

Hash marks indicate TWO MOA spacing @ 18x

ZMOA-4 (1-6x24)

Hash marks indicate FOUR MOA spacing @ 6x

Traditional Hunting Reticles

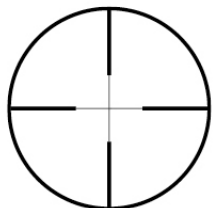

Reticle #6

Plex Style, Non-Illuminated

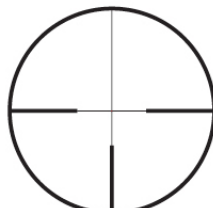

Reticle #60

Plex Style, Illuminated Center Dot

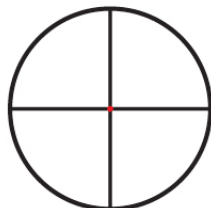

Illuminated Center Dot

(For illustration purposes.)

More reticles may be added from time to time. Please visit www.zeiss.com/us/sports-optics for the latest information and product offerings.

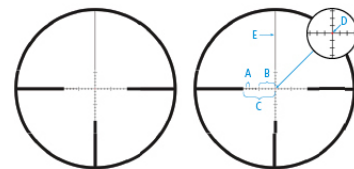

ZMOA

1-6x24

Reticle

ZMOA-4

Magnification

@ 6x

	MOA	in / 100 yds	cm / 100 m
Distance A	4	4.19	11.64
Distance B	20	20.95	58.20
Opening C	40	83.81	232.80
Line Thickness E		0.53 @ 6x	
Dot Diameter D		0.38 @ 6x	

RETICLES (SECOND FOCAL PLANE) - CONTINUED

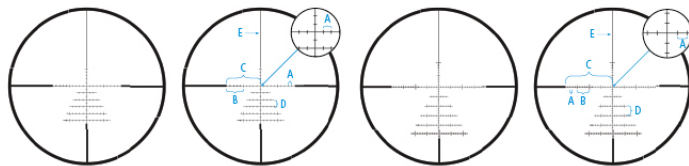

ZBR	3-18x50			5-30x50		
Reticle	ZBR-2			ZBR-1		
Magnification	@ 18x			@ 25x		
	MOA	in / 100 yds	cm / 100 m	MOA	in / 100 yds	cm / 100 m
Distance A	2	2.10	5.82	1	1.05	2.91
Distance B	10	10.48	29.10	5	5.24	14.55
Opening C	20	41.91	116.42	20	41.91	116.42
Distance D	4	4.19	11.64	4	4.19	11.64
Line Thickness E	0.19 @ 18x			0.14 @ 25x		

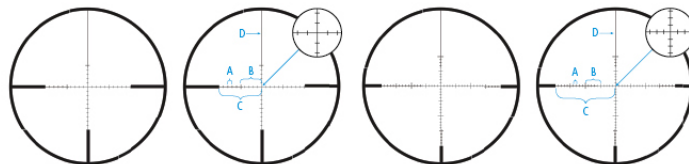

ZMOA	3-18x50			5-30x50		
Reticle	ZMOA-2			ZMOA-1		
Magnification	@ 18x			@ 25x		
	MOA	in / 100 yds	cm / 100 m	MOA	in / 100 yds	cm / 100 m
Distance A	2	2.10	5.82	1	1.05	2.91
Distance B	10	10.48	29.10	5	5.24	14.55
Opening C	20	41.91	116.42	20	41.91	116.42
Line Thickness D	0.19 @ 18x			0.14 @ 25x		

CONQUEST V6 SCHEMATIC

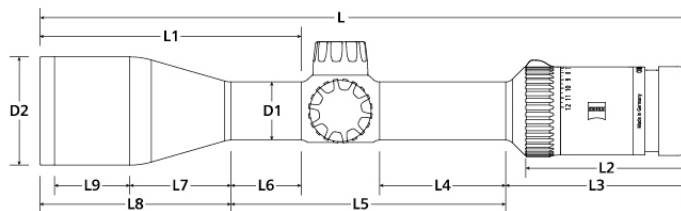

	D1	D2	L	L1	L2	L3	L4	L5	L6	L7	L8	L9
Conquest V6 1-6x24	30.0 mm	1.18	11.22	3.53	3.33	3.70	2.57	-	-	-	-	-
Conquest V6 3-18x50	30.0 mm	2.20	13.30	5.35	3.33	3.70	1.99	5.89	1.65	1.89	3.72	1.54
Conquest V6 5-30x50	30.0 mm	2.20	14.96	7.00	3.33	3.70	1.99	6.10	1.78	2.19	5.14	2.64

Measurements above are listed in inches, unless otherwise noted.

POWER THROW LEVER (OPTIONAL ACCESSORY)



Note: Actual product may vary slightly than image illustrated above.



CARING FOR YOUR RIFLESCOPE

Ensure your ZEISS riflescope is **NOT** exposed to extreme heat over prolonged periods of time, such as those elevated temperatures sometimes found inside of a vehicle on a sunny day.

Your ZEISS riflescope is designed and manufactured to give you many years of reliable and long-term service. One of the best ways to protect your optical investment is to be sure and use appropriate lens covers when you are not using your riflescope. To further protect your riflescope, ZEISS strongly suggests you keep the product clean and free of troublesome sand, dirt, salt water, and various contaminants.

Cleaning Your ZEISS Riflescope's Exterior

For a heavily soiled riflescope, you can rinse the riflescope under a stream of cool or warm water, and then wipe it down with a water-moistened towel. Do not use strong solvents to clean your riflescope or its optics. Using such solvents will void the ZEISS warranty.

STOP: When cleaning your rifle and rifle barrel, **PLEASE ENSURE THAT THE RIFLESCOPE'S LENS COVERS ARE IN PLACE FIRST.** These types of cleaning solvents can and will destroy the fine and precision multilayer lens coatings.

Cleaning Your Lenses

ZEISS recommends using original ZEISS branded lens cleaning solutions, supplies, and complete cleaning kits to care for the lenses on your riflescope.

First, permit heavy or large debris on the lens surfaces to fall away from the surface. Try to carefully remove loose dirt and dust with a lens brush.

STOP: Do **NOT** use the types of compressed air cans found typically in the office supply section of various retail outlets. When used improperly, they can destroy lens coatings, causing the coatings to peel away or blister from the lens surface.

You can also remove stubborn grit and other contaminants by gently flushing the surface with distilled water. With these larger contaminants removed, you can now gently swab the lenses clean by following the respective lens cleaning instructions.

ZEISS strongly suggests using a clean, lint-free, pre-moistened microfiber cleaning cloth or appropriate lens swab and an appropriate lens cleaning solution. Starting in the center of the lens, begin swabbing in a circular motion, working toward the outside. Once you reach the outer diameter of the lens you are cleaning, use a new swab or another portion of the microfiber cloth to avoid streaking the lenses with contaminants and grease frequently located where the lens comes in contact with the metal lens housing. Make only one pass to the edge where the glass meets the metal. Repeat this process as necessary until desired results are achieved. TIP: Use only a small amount of cleaning solution for the final lens swabbing to prevent streaks.

Long-Term Storage

ZEISS suggests you remove the battery – where applicable – if the riflescope will not be used for a prolonged period of time. Store the riflescope in a cool, dry, clean, and contaminant-free location.

ZEISS WARRANTY – NORTH AMERICA

The ZEISS Limited Lifetime Transferable Warranty (“Limited Warranty”)

Subject to limitations on electronic components, camera electronics and accessories described below, your ZEISS product (“product”) is warranted against defects in workmanship or materials for the life of the product. If a defect that is covered by this Warranty is found, ZEISS will, at its option and without charge, either repair your product or replace it with a ZEISS product of comparable specifications and value. This Warranty is transferable.

Limited Warranty Conditions for Electronic Components, Camera Electronics and Accessories

Electronic components are warranted against defects in workmanship or materials for a period of 5 years from the original date of purchase. Camera electronics are warranted against defects in workmanship or materials for a period of 2 years from the original date of purchase. Carrying straps, lens caps, rubber armoring, plastic parts and similar accessories are warranted against defects in workmanship or materials for a period of 1 year from the date of purchase.

Warranty Disclaimers and Exclusions

This is the exclusive Warranty for the products. All other warranties, expressed or implied, statutory or otherwise, including, without restriction, those of merchantability or of fitness for use, are excluded. Only products imported by Carl Zeiss SBE, LLC and purchased in the United States or Canada from authorized Carl Zeiss SBE, LLC dealers carry this Limited Lifetime Transferable Warranty. Carl Zeiss SBE, LLC will not provide warranty service for products purchased through unauthorized dealers.

This Warranty excludes claims for any special, punitive, incidental or consequential damages and does not cover damages due to the misuse, neglect, accidental damage, mishandling or alteration of the Product. Some states do not allow the exclusion or limitation of incidental or consequential damages. In such cases, the above limitations or exclusions may not apply to you.

This Warranty is void, if damage is caused by the use of accessories not sold or authorized by Carl Zeiss SBE, LLC or from service by persons not authorized by Carl Zeiss SBE, LLC.

Continued on following page.

This Warranty does not cover claims resulting from natural disasters (e.g., floods, storms, fire), acts of war or terrorism and will not apply to damage arising from combat conditions, including but not limited to, damage due to firearms, explosives, nuclear, chemical, or biological weapons. It will be at ZEISS's sole discretion to extend service under this Warranty for damage arising from the above-mentioned conditions. ZEISS's obligation under this warranty is limited to repair or replacement by equivalent product in working condition, at ZEISS's discretion.

The customer's benefit is to help ensure expedited service, communicate special offers, and share pertinent product updates.

Be sure to register your product. www.zeiss.com/sports-optics

NO-FAULT POLICY (CONQUEST V6 RIFLESCOPES)

Every product we make is backed by an industry leading, limited lifetime, transferable warranty. In addition, on selected products we offer a No-Fault Policy. For these products we will repair or replace product damaged during normal and intended use, without charge to you, **for the first five years of ownership**. We want you to buy our products with the same kind of confidence they inspire in the field. For more information, visit www.zeiss.com/sports-optics/us-no-fault-policy

CONSUMER PRODUCT RETURNS – NORTH AMERICA

STOP: Before sending a riflescope in for service, please call ZEISS Sports Optics Customer Care team at the number below in order to determine if the issue/concern can be resolved without having to return the product.

1-800-441-3005
info.sportoptics.us@zeiss.com

After your initial inquiry, if it was determined that your ZEISS product needs to be sent in for evaluation, service, or repair, Customer Care will then provide you with the ZEISS Service/Repair document. This is a PDF document, configured as an easy-to-use auto-fill solution to be completed from your computer. **Please complete all sections of the Service/Repair document. Afterward, save it for future reference, print it, and include the printed copy with the product you are returning for service.**

Be sure to place the appropriately wrapped and protected product in a proper shipping container. Insure it for replacement value, and ship it shipping prepaid to the appropriate address listed below.

USA Residents: Please send to ZEISS Service/Repair Dept.

Carl Zeiss SBE, LLC
Consumer Optics Repair Service
One Zeiss Drive
Thornwood, NY 10594
P: 1-800-441-3005

Canadian Residents: Please send to ZEISS Authorized Distributor:

Gentec
90 Royal Crest Court
Markham, Ontario
CANADA L3R 9X6
P: 905-513-7733

Rest of the World:

Due to legal requirements and export/import restrictions, any product exported or sold outside the United States and Canada must be returned to the original point of purchase, with a copy of the invoice or your product registration information.

DO NOT return exported items directly to Carl Zeiss Optical, Inc. from outside the United States.

DO NOT return exported items directly to Gentec International from outside Canada.

Carl Zeiss SBE, LLC and Gentec International cannot accept products from or ship products to locations outside the United States and Canada.

This process is subject to improvements and changes.

CONQUEST V6 SPECIFICATIONS

Model	V6		
	1-6x24	3-18x50	5-30x50
Magnification	1.1x – 6.5x	3x – 18x	5x – 30x
Focal Plane	Second	Second	Second
Effective Lens Diameter	10.5 mm – 24 mm	28.6 mm – 50 mm	47.8 mm – 50 mm
Exit Pupil Diameter	9.6 mm – 3.7 mm	9.5 mm – 2.8 mm	9.5 mm – 1.7 mm
Twilight Factor	3.1 – 12.5	8.5 – 30	14.1 – 38.7
Field of View at 100 yds	102.6 ft – 16.8 ft	37.2 ft – 6.3 ft	22.2 ft – 3.6 ft
Angular Field of View, Real	19.4° – 3.2°	7.1° – 1.2°	4.2° – 0.7°
Diopter Range		+2 / -3 dpt	
Eye Relief		3.5 in	
Parallax Setting	100 yds	50 yds – ∞	50 yds – ∞
Elevation Adjustment Range	103 MOA	103 MOA	62 MOA
Windage Adjustment Range	103 MOA	58 MOA	34 MOA
Click Value	0.5 MOA	0.25 MOA	0.25 MOA
Main Tube Diameter		30 mm	
Eyepiece Tube Diameter		45.5 mm	
Objective Tube Diameter	30 mm	56 mm	56 mm
Coating	LotuTec® / ZEISS T*		
Fogproof	Nitrogen Purged		
Waterproof	400 mbar (submerged 4 meters for 2 hours)		
Operating Temperature	-12 / +122° F		
Length	11.2 in	13.3 in	14.9 in
Weight	17.8 oz	22.2 oz	27.9 oz
Reticles	#60 <i>illum.</i> , ZMOA-4 <i>illum.</i>	#6, ZBR-2, ZMOA-2	#43, ZBR-1, ZMOA-1

ZEISS Sports Optics is not responsible for typographical errors. Product images are for illustration purposes only. Specifications and products may change without prior written notice. All efforts have been made to make sure content is accurate at time of printing.

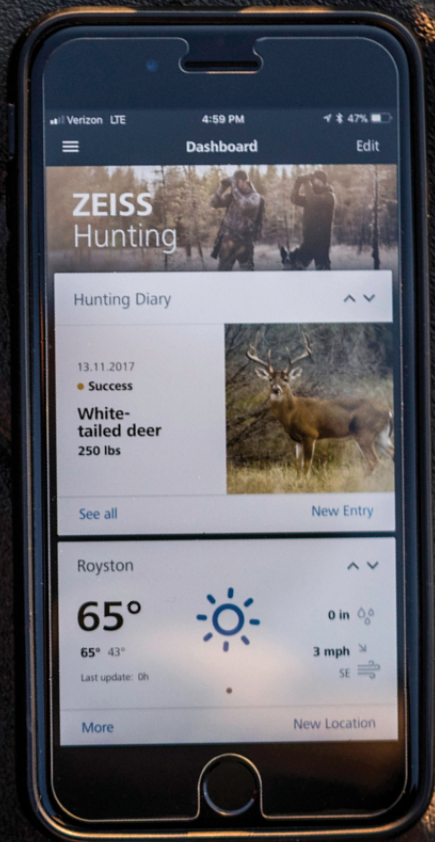

ZEISS HUNTING APP

iOS / Android Compatible

In order to maximize the use, features, and benefits of your ZEISS riflescope, we invite you to download the Zeiss Hunting App. This free app offers unique and easy-to-use information at your fingertips.

Hunt longer. Hunt better.
Hunt with confidence.
ZEISS.



Carl Zeiss Sports Optics North America

Carl Zeiss SBE, LLC
Consumer Optics Business Group
Sports Optics Division
1 Zeiss Drive
Thornwood, NY 10594
www.zeiss.com/us/sports-optics

   | JOIN THE CONVERSATION

