



Trijicon ACOG®



There's a reason the Trijicon ACOG® (Advanced Combat Optical Gunsight) is the official medium-distance engagement optic of the U.S. Marine Corps and U.S. Special Operations Forces. And why more than one million have been produced. Each one is specifically engineered to provide increased hit potential in all lighting conditions, while also providing legendary durability and reliability.

- 1 Ruggedized forged housing delivers combat proven durability and reliability
- 2 Bindon Aiming Concept (BAC) features both eyes open shooting for improved situational awareness
- 3 Battery free tritium/fiber optic illumination provides brilliant aiming point in any lighting, LED versions also available
- 4 BDC reticles available in most magnifications along with target-ranging reference points
- 5 Fixed magnifications available from 1.5x to 6x

The Science of Brilliant®

At Trijicon, we are bound by a commitment to industry-leading research, design, and testing to seek innovative aiming solutions that constantly redefine "brilliant." That's why every Trijicon riflescope design is tested to the procedures below.



- > **Alaska-to-Africa Temperature Tested**
To ensure each family of riflescopes is ready for whatever our users put them through, we perform an "Alaska-to-Africa" temperature shock test with temps from -20°F to 140°F.
- > **Solid Zero Tested**
Our riflescopes are designed to hold their zero giving you the precision you need. Every model is subjected to 5,000 consecutive rounds, confirming no reticle shift has occurred.

- > **Drop Tested**
Because we don't believe every drop should be followed by a warranty claim, we drop test each riflescope design to check for durability.
- > **Shock & Vibration Tested**
All riflescope models are tested to withstand recoil and vibrational stresses without malfunction, so it can take a beating before, during, and after use.
- > **Immersion Tested**
All models are immersion tested, and every riflescope is dry-nitrogen filled to eliminate internal fogging.

Features and Benefits



- A Always On, Always Ready**
Most ACOG® models are battery-free, featuring a tritium/fiber optic-illuminated reticle that automatically adjusts the brightness based on available light.
- B Outstanding Clarity**
The quality of the glass and multi-coated lenses maximizes light-gathering capabilities and clear field of view with zero distortion.
- C Rugged Aluminum-Alloy Housing**
Fixed-power design allows for minimal moving parts to create a nearly indestructible sighting system.
- D Exact Target Distances & Holds**
Most ACOG models feature a bullet dropcompensating and target-ranging reticle for decisive aiming.
- E Combat Proven**
No other magnified optic has been used more in combat than the ACOG.
- F Shock-Resistant**
Proven to withstand recoil from a .22LR to a .50BMG and everything in between. Easily passes U.S. Military drop test requirements.

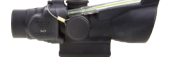

	1.5x16s (TA44 Series)	1.5x24 (TA45 Series)	2x20 (TA47 Series)	3x24 (TA50 Series)
Magnification	1.5x	1.5x	2x	3x
Objective Lens	16mm	24mm	20mm	24mm
Eye Relief	2.4 in. 61.0mm	3.6 in. 91.4mm	2.1 in. 53.3mm	1.4 in. 35.6mm
Exit Pupil	0.42 in. 10.7mm	0.63 in. 16.0mm	0.39 in. 10.0mm	0.31 in. 8.0mm
Field of View (in degrees)	7.4°	4.9°	5.6°	4.9°
Field of View	39.0 ft. @ 100 yds. 12.9m @ 100m	25.6 ft. @ 100 yds. 8.6m @ 100m	29.31 ft. @ 100 yds. 9.8m @ 100m	25.6 ft. @ 100 yds. 8.6m @ 100m
Adjustments (PER IN. @ 100 YDS.)	2 clicks	2 clicks	2 clicks	2 clicks
Dimensions (L x W x H) W/O MOUNT	4.0 x 1.6 x 2.1 in. 102 x 42 x 53mm	5.8 x 1.6 x 2.1 in. 147 x 42 x 53mm	5.3 x 1.6 x 2.1 in. 135 x 42 x 53mm	5.0 x 1.8 x 2.1 in. 127 x 46 x 53mm
Weight W/O MOUNT	5.1 oz. 144.5g	6.3 oz. 179.1g	6.4 oz. 180.6g	6.1 oz. 173.0g
Illumination Source	Fiber Optics & Tritium	Fiber Optics & Tritium	Fiber Optics & Tritium	Fiber Optics & Tritium
Battery Life	N/A	N/A	N/A	N/A
Reticle Calibration	N/A	N/A	N/A	.223 / 7.62x39

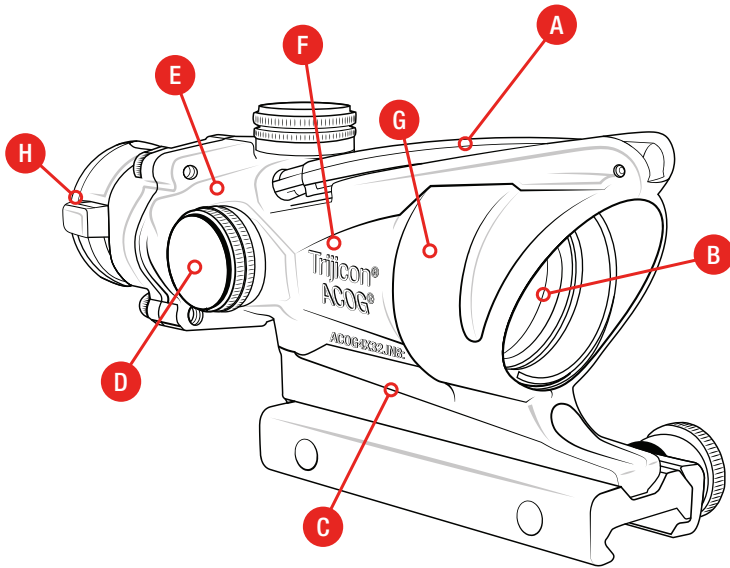

- G Waterproof**
Exceptional waterproof performance. Dry nitrogen-filled to eliminate fogging and tested to perform in both extreme cold and heat.
- H “Both Eyes Open” Design**
Can be used as a CQB sight when shooting “both eyes open” using the Bindon Aiming Concept.



3x30
(TA33 Series)



3.5x35
(TA11 Series)



3.5x35 LED
(TA110 Series)



4x32
(TA01 Series)

3x	3.5x	3.5x	4x
30mm	35mm	35mm	32mm
1.9 in. 48.3mm	2.4 in. 61.0mm	2.4 in. 61.0mm	1.5 in. 38.1mm
0.33 in. 8.4mm	0.39 in. 9.9mm	0.39 in. 10.0mm	0.32 in. 8.1mm
3.7°	5.5°	5.5°	7.0°
19.3 ft. @ 100 yds. 6.5m @ 100m	28.8 ft. @ 100 yds. 9.6m @ 100m	28.8 ft. @ 100 yds. 9.6m @ 100m	36.6 ft. @ 100 yds. 12.2 @ 100m
4 clicks	3 clicks	2 clicks	2 clicks
6.1 x 1.6 x 2.1 in. 155 x 42 x 53mm	8.0 x 2.1 x 2.6 in. 203 x 53 x 66mm	8.0 x 2.1 x 2.6 in. 203 x 76 x 66mm	5.8 x 2.0 x 2.3 in. 147 x 51 x 58mm
7.8 oz. 221.1g	14.0 oz. 396.9g	16.8 oz. 476.3g	10.9 oz. 309.0g
Fiber Optics & Tritium	Fiber Optics & Tritium	LED Powered by a AA Battery	Tritium Only
N/A	N/A	12,000+ hours*	N/A
.223 / .308 / 7.62x39 / 300 BLK	.223 / .308 / M193 / 300 BLK	.223 / .308	.223 / .308



One Million ACOG® Riflescopes
2018 Limited Commemorative Edition

Specifications



4x32 BAC
(TA31 Series)



4x32 LED
(TA02 Series)



5.5x50
(TA55 Series)







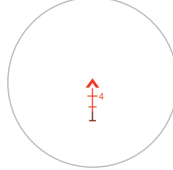
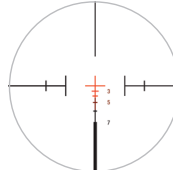
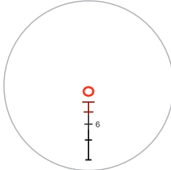
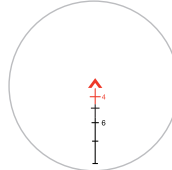

6x48
(TA648 Series)

4x32 BAC (TA31 Series)	4x32 LED (TA02 Series)	5.5x50 (TA55 Series)	6x48 (TA648 Series)
4x	4x	5.5x	6x
32mm	32mm	50mm	48mm
1.5 in. 38.1mm	1.5 in. 38.1mm	2.2 in. 55.9mm	2.7 in. 68.6mm
0.32 in. 8.1mm	0.32 in. 8.1mm	0.36 in. 9.1mm	0.32 in. 8.1mm
7.0°	7.0°	3.5°	3.3°
36.6 ft. @ 100 yds. 12.2 @ 100m	36.6 ft. @ 100 yds. 12.2 @ 100m	18.3 ft. @ 100 yds. 6.1m @ 100m	17.3 ft. @ 100 yds. 5.8m @ 100m
2 clicks	2 clicks	5 clicks	4 clicks
5.9 x 2.0 x 2.5 in. 150 x 51 x 64mm	6.0 x 2.9 x 3.0 in. 153 x 74 x 76mm	12.0 x 2.5 x 2.7 in. 305 x 64 x 69mm	9.0 x 2.9 x 3.4 in. 229 x 74 x 86mm
10.5 oz. 297.5g	18.1 oz. 513.1g	25.6 oz. 725.8g	36.9 oz. 1046.1g
Fiber Optics & Tritium	LED Powered by a AA Battery	Fiber Optics & Tritium	Fiber Optics & Tritium
N/A	12,000+ hours*	N/A	N/A
.223 / .308 / M193 / 300 BLK / 6.8 SPC	.223 / 300 BLK	.223 / .308	.223 / .308 / .50 BMG

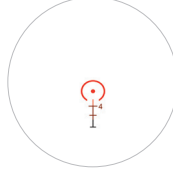
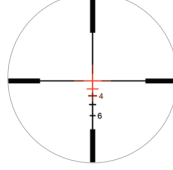
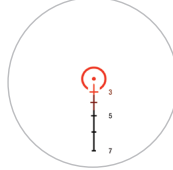
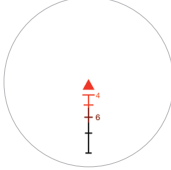
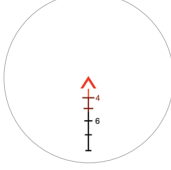
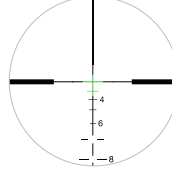
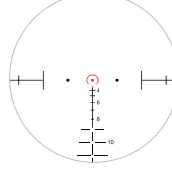
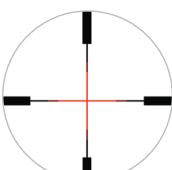
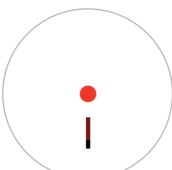
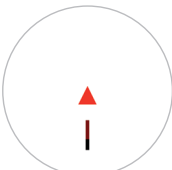
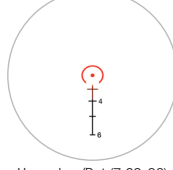
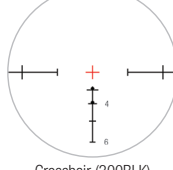

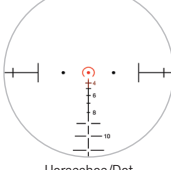
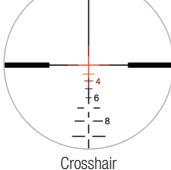







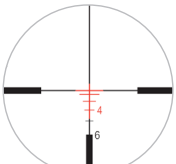

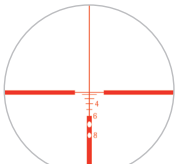

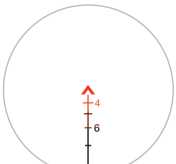

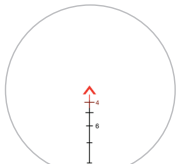

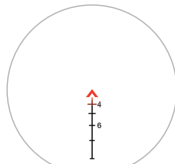



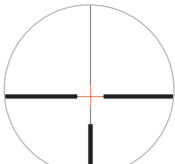

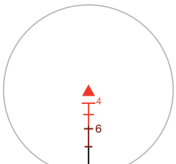

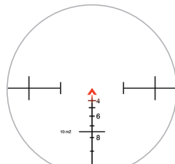

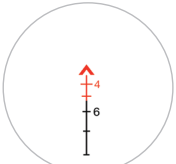



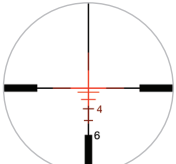

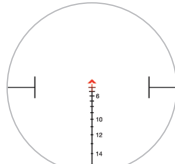

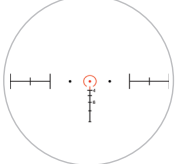

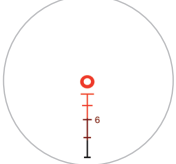

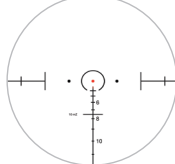
*When used at 70°F (21°C) on setting 4 of 6 with supplied alkaline battery. Extreme temperatures (high or low) will affect battery performance.

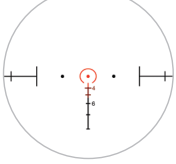
Available Reticles

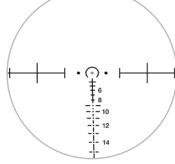
1.5x16S	3x30	3x24	3.5x35	3.5x35 LED
 <p>Circle Dot ■ ■ ■</p>	 <p>Chevron ■ ■ ■</p>	 <p>Crosshair ■ ■ ■</p>	 <p>Donut ■ ■</p>	 <p>Chevron ■ ■</p>
<p>1.5x24</p>  <p>Triangle ■ ■</p>  <p>Crosshair ■ ■</p>	 <p>Horseshoe/Dot (.223) ■ ■ ■</p>  <p>Crosshair ■ ■ ■</p>	 <p>Horseshoe Dot ■ ■ ■</p>	 <p>Triangle ■</p>  <p>Chevron ■ ■ ■</p>	 <p>Crosshair ■ ■</p>  <p>Horseshoe/Dot ■ ■</p>
<p>2x20</p>  <p>Crosshair ■ ■ ■</p>  <p>Dot ■ ■</p>  <p>Triangle ■ ■</p>	 <p>Horseshoe/Dot (7.62x39) ■ ■ ■</p>  <p>Crosshair (300BLK) ■ ■ ■</p>		 <p>Circle Chevron ■</p>  <p>Horseshoe/Dot ■ ■</p>  <p>Crosshair ■ ■ ■</p>  <p>Horseshoe/Dot (M249) ■</p>	

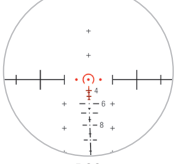
Reticles not shown to scale. For a full view of reticles, please visit our website at Trijicon.com.

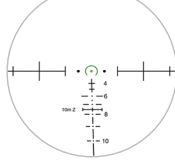
Available Reticles

4x32 LED	4x32	4x32 BAC	5.5x50	6x48
 Crosshair 	 Full Illumination Crosshair 	 Chevron 	 Chevron 	 Chevron (.223) 
 Crosshair (300BLK) 	 LAPD Crosshair 	 Triangle 		 Chevron (.308) 
 Chevron 	 Center Illuminated Crosshair 	 Crosshair 		 Chevron (.50) 
 Horseshoe/Dot 		 Donut 		 Horseshoe/Dot (.308) 
		 Horseshoe Dot 		 Horseshoe/Dot (M2) 
		 RCO 		 Horseshoe/Dot (M240) 

Reticles not shown to scale. For a full view of reticles, please visit our website at Trijicon.com.