

SIGHT  MARK<sup>®</sup>

USER MANUAL

---

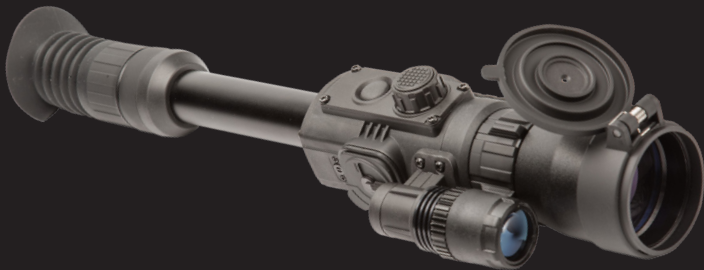

SM18015  
SM18016  
SM18017  
SM18018

**Photon RT Digital Night Vision Riflescope**

## ABOUT SIGHTMARK®

Sightmark offers a wide range of products that include red dot scopes, reflex sights, rangefinders, riflescopes, laser sights, night vision, binoculars and award-winning flashlights and boresights. Sightmark products are inspired by military and law enforcement applications. All products are designed to be the most effective weapon accessories possible.

MAKE YOUR MARK



[www.sightmark.com](http://www.sightmark.com)

## ABOUT

Photon RT digital riflescopes are designed for the use in the twilight and nighttime. The rifle-scope is equipped with an electronic reticle featuring a number of shape and colour options. The riflescopes can be mounted using regular mounting brackets for day sights. The riflescope has a built-in LED IR Illuminator with a wavelength of 850nm (visible range) or 940nm (invisible range) used for operation in total darkness. Photon RT digital riflescopes are designed for hunting, sports shooting, security, general observation.

TECHNICAL SPECIFICATIONS	SM18015	SM18016	SM18017	SM18018
Sensor resolution, pixels	768x576	768x576	768x576	768x576
Display type	LCD	LCD	LCD	LCD
Display Resolution, pix.	640x480	640x480	640x480	640x480
Magnification	4.5 / 9	4.5 / 9	6 / 12	6 / 12
Lens diameter, mm	42	42	50	50
Digital zoom	2x	2x	2x	2x
Field of View, ft@100yd	22.5	22.5	18	18
Eye Relief, mm	2.76 / 70	2.76 / 70	2.76 / 70	2.76 / 70
Resolution, lines per mm	40	40	40	40
IR Emitter	LED	LED	LED	LED
IR Wavelength, nm	850	940	850	940
Equivalent IR Power, mW	200	100	200	100
Range of detection, yd/m	220 / 200	150 / 140	300 / 280	200 / 180
Battery type	4xAA	4xAA	4xAA	4xAA
Battery Life (with IR), hour	3.5	3.5	3.5	3.5
Windage & Elevation, 1 click = Mil	.1	.1	.1	.1
Tube diameter	30mm	30mm	30mm	30mm
Length, in/mm	16.57 / 421	16.57 / 421	18 / 458	18 / 458
Width, in/mm	3.93 / 100	3.93 / 100	3.93 / 100	3.93 / 100
Height, in/mm	3.62 / 92	3.62 / 92	3.62 / 92	3.62 / 92
Weight (with batteries), oz	30.7	30.7	32.8	32.8

## INCLUDED ACCESSORIES:

- Carrying case
- User manual
- USB cable
- Spare battery container
- Battery container pouch
- Lens cloth

## FEATURES:

- Wifi remote view via Pulsar Stream Vision
- Built-in video/sound recording
- 2x digital zoom
- 6 reticle options with 4 colors
- Power input
- One shot zero
- Built-in LED IR illuminator
- Resistant to bright light exposure

## DIAGRAM

- |                          |                              |
|--------------------------|------------------------------|
| 1. Objective lens        | 8. USB port                  |
| 2. Flip-up lens cover    | 9. Built-in microphone       |
| 3. Control knob          | 10. Battery container        |
| 4. On/off button         | 11. Record button            |
| 5. Diopter adjustment    | 12. IR illuminator lock ring |
| 6. Lens focus ring       | 13. IR adjustable focus      |
| 7. Accessory weaver rail | 14. Mounting tube            |

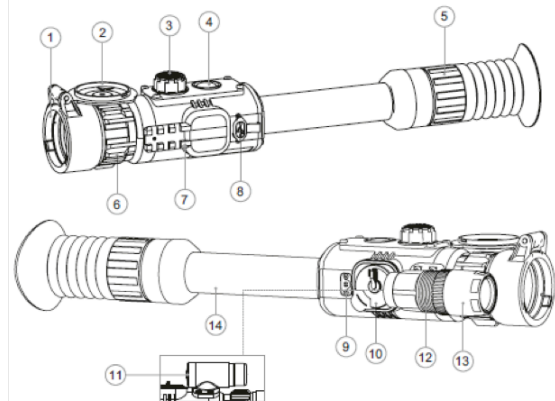

## BATTERY INSTALLATION

The Sightmark Photon RT uses four AA batteries. It is recommended to use batteries of the same type and same charge for best performance. It is safe to use rechargeable batteries with the Photon RT.

### To install the batteries:

1. Turn the knob on the cover of the battery container (10) 90° counterclockwise to the open position.
2. Pull out the battery container using the lug on the bottom left of the cover.
3. Insert the batteries into the battery container. Make note that the battery polarity matches the positive and negative symbol marked on the walls of the container.
4. Insert the battery container back into the battery compartment. Make sure the container is inserted properly so that the container's contacts match up with the contacts inside the battery compartment.
5. Turn the knob on the battery container 90° clockwise to lock it in place.

**Note:** the battery charge icon on the display will show current charge level of the batteries. When the batteries are near depletion the battery indicator light will turn red and flash.

**Warning!** Remove the battery container from the device during storage and transportation. To prevent short circuit and overheating, store and carry the battery container in the supplied pouch. Not following this safety procedure can cause batteries to quickly lose charge and possibly overheat potentially damaging the product, and any personal items stored with the battery container.

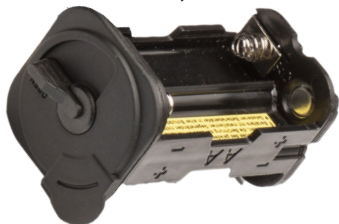

## EXTERNAL POWER SUPPLY

The Sightmark Photon RT can be powered by an external power supply such as a 5V power bank or even your personal computer.

### To connect the Photon RT to external power:

1. Connect the provided microUSB cable to the USB port (8) on the riflescope.
2. Connect the other end of the USB cable to a power bank or PC.
3. On the riflescope's display two icons will appear, plug icon (power) and computer icon (storage device). Select the plug icon by rotating and pressing the controller to select.
4. The battery icon on the display will switch to the plug icon. The riflescope is now operating using the external power only.

**Note:** When AA batteries are in the unit and an external power source is used, the unit operates on the external power source only. When the unit is disconnected from a power bank or external power supply, the Photon will automatically switch to internal batteries. When using rechargeable AA batteries in the Photon RT, plugging the Photon RT into an external power source DOES NOT recharge the batteries in the unit.



## MOUNTING

The Sightmark Photon RT riflescope requires 30mm scope rings (not included) for mounting. Mount the scope per the scope ring manufacturer's instructions. Do not perform a final tightening of the rings prior to checking eye relief and reticle alignment. Initially the riflescope should still be able to move for and after and rotate when installed in the rings.

### To achieve maximum eye relief:

1. Turn the Photon RT on and focus the image. Set the riflescope far forward in the rings and slowly move the riflescope closer to your eye. Stop moving the riflescope once a full field of view is visible.
2. Next rotate the scope to vertically align the crosshair. Use a reticle leveling tool if available.
3. Once alignment is complete, tighten the mounting ring's screws evenly so the gap is even on both sides of the scope. Do not over tighten.

**Warning!** If the riflescope is not setup correctly with proper eye relief and is mounted too close to the shooter's eye, it's rearward motion due to firearm recoil may cause injury to the shooter. To zero the scope, see section "One Shot Zeroing".

## ON/OFF ACTIVATION

The Sightmark Photon RT controls are located on top of the unit for easy access.

### To power the unit on:

1. Open the lens cover (2) if using at night. If using in daylight, keep cover closed.
2. Locate the on/off button (4) on top of the unit.
3. To turn the unit on, press the on/off button once. The display will turn on after several seconds.
4. To turn the display off, press the on/off button again for one second.
5. The message "Display off" will appear on the screen. This mode saves battery life when the riflescope is not being used in the field, but operation can be started again quickly by briefly pressing the on/off button again.

6. To turn the unit off, press and hold the on/off button for 3 seconds.

## DIOPTER ADJUSTMENT

The Sightmark Photon RT's eyepiece (5) is designed to rotate to adjust for diopter. If the display does not appear clear, crisp, nor sharp, rotate the eyepiece until the reticle becomes clear and sharp. This adjustment should stay the same unless the riflescope's operator changes. To adjust the eyepiece:

1. Locate the eyepiece (5) on the back of the unit.
2. While looking through the eyepiece, rotate the eyepiece until the display and its icons are clear and crisp.

## FOCUSING

The Sightmark Photon RT's lens focus ring (6) allows the riflescope to deliver a clear, sharp image. Anytime the viewing distance of a target is changed, generally the image must be refocused. To focus the image:

1. Turn the lens focus ring (6) until the image is focused. Make sure the image is always well focused as this will prevent eye fatigue.

## ADJUSTING DISPLAY BRIGHTNESS

The Sightmark Photon RT's display is equipped with adjustable brightness. This allows the brightness to be customized to the user's preference.

### To adjust the display brightness:

1. Locate the controller (3) on top of the unit to control brightness.
2. Rotate the controller clockwise to increase brightness.
3. Rotate the controller counter clockwise to decrease brightness. The brightness level, 0-20, is shown on the display.

## USING THE IR ILLUMINATOR

The Sightmark Photon RT is equipped with a built-in IR illuminator for use in low light conditions or in complete darkness. The brightness control of the IR illuminator is done by using the controller knob. The IR illuminator is also equipped with focus beam adjustment. Finally, the IR illuminator can be aligned to center the beam focus to the Photon RT's field of view.

### To activate the IR illuminator:

- 1) Turn on the Photon RT. The IR illuminator will automatically turn on to the lowest power, IR1.
- 2) Press the controller (3) to display the quick function system which consists of icons for brightness, IR brightness, and magnification.
- 3) Rotate the controller to highlight the IR icon and press the controller to select.
- 4) To change power level from 1 to 10 rotate the controller.
- 5) To turn the IR illuminator off, rotate the controller to "off". Next a crossed out icon,  , will appear on the display.



**Note:** the IR illuminator power is not saved in the rifle's memory. Each time the scope is turned off and back on, the IR setting returns to IR1 brightness level. You cannot operate the IR illuminator when in REVIEW mode. When REVIEW mode is activated, the IR illuminator turns off and the IR icon is not seen on the display. The power level is saved in this circumstance. Upon exiting REVIEW mode, the IR illuminator returns to the last used power level.

### To focus the IR illuminator:

1. Locate the head (13) of the IR illuminator, which serves as the focus adjustment.
2. Rotate the head to change the focus from spot to flood.

### To align the IR illuminator:

1. Locate the lock ring (12) located behind the focus head of the IR illuminator.
2. Turn the lock ring 5 to 10 degrees counterclockwise.
3. Next, move the IR illuminator hood vertically and horizontally to align the IR's beam focus with the center of the image.
4. Once centered, tighten the lock ring.



## USING DIGITAL ZOOM

The digital zoom function allows you to control the Photon's magnification. Each Photon RT model is equipped with 2x digital zoom. When digital zoom is activated, the full magnification value is shown on the display.

### To activate the zoom function:

- 1) Press twice on the controller (3) to select the zoom icon.
- 2) Rotate the controller to cycle between the optical magnification and the 2x zoom. For example, the 4.5x Photon will change to 9x when the 2x digital zoom is applied. The 6x Photon will change to 12x magnification when the 2x digital zoom is applied.

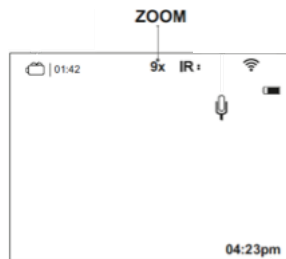

**Note:** digital zoom is not saved in the riflescope's memory. Each time the scope is turned off and back on, digital zoom is turned off and the magnification will be set to the optical magnification (i.e. 4.5x or 6x).

## DISPLAY OFF FUNCTION

This function deactivates the display, which eliminates light exposure caused by the glowing display, but also saves battery life when the unit is not being used for viewing.

### To turn off the display:

1. Press and hold down the on/off button (4) for more than one second.
2. The display will turn off and will show the message "Display Off".
3. To turn the display on, briefly press the on/off button again.

**Note:** when the display off function is activated, all controls are inactive except for the on/off button. Remote viewing through Wi-Fi function will continue to function. Video recording also will continue to record if recording was activated before the display off function was activated. Finally, the display off function will deactivate if the unit is connected to a PC via the USB port or to an external power supply

## USB CONNECTION

The Photon RT can be connected to a PC via the USB port (8). The PC will detect the Photon automatically, no driver installation is necessary. With the Photon turned on and connected to a PC, the display will show two icons: plug icon (power) and computer icon (storage device). Rotate the controller to change between the two modes. Press the controller to select the desired mode.

### USB Mass Storage Device

If this option is selected, the unit is detected by the PC as a storage device. The unit switches to USB power and will not use up the AA batteries. This mode allows the transfer of recording videos and photos from the Photon RT's memory to the PC. In this mode the unit's functions are deactivated.

## Power

When this option is selected, the PC is used to power the unit. The external power icon appears on the display in place of the battery charge icon. Typically, this mode is used with a power bank for longer operating times out in the field.

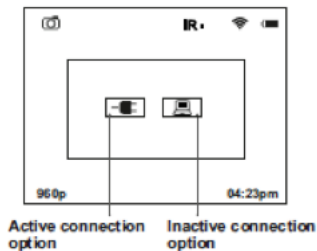

Connection in various operating modes





Connection option	Operating mode	Status of the unit
USB	Video/Photo	The unit is "off". If video recording is on when the connection is made, the recording is stopped and saved automatically.
	Review	The unit is "off". If a video is being reviewed when the connection is made, the review stops.
Power	Video/ Photo/Review	The unit continues to function.

## USB Disconnection

When the Photon is selected as a USB mass storage device and the USB cable is disconnected from the PC, the unit will remain turned off. The Photon must be powered on to continue operation.

When the Photon is in power mode and the USB cable is disconnected from the PC, the unit will turn off. The unit must be turned back on in order to be detected by the PC.

## OPERATING MODES



The Photon RT is equipped with 3 operation modes: video, photo, and review. Video mode allows for video recording of what is seen on the display. Video mode is the default mode and will be active each time the unit is turned on. When the Photon is using video mode, the  (camcorder) icon is shown on the display. If sound recording is activated, the  (mic) icon is also shown on the display. Photo mode allows for image capture of what is seen on the display. When the Photon is photo mode, the  (camera) icon is shown on the display. Review mode allows the user to see previously recorded videos or pictures. When in Review mode the  (picture) icon will be shown on the display if a photo is being displayed or the  (video) icon will be shown if a video is being displayed.

### In order to switch between modes:

1. Locate the record button (11) on the back of the IR illuminator.
2. Switch between modes by a long press of the record button.
3. The modes will cycle between Video, Photo, and Review.



## Video Mode

Video mode is the default mode each time the Photon is turned on. The  (camcorder) icon is shown on the display to notify the user it is in video mode and will record video. If sound recording is activated the  (mic) icon is also shown on the display. Users can still enter and navigate the menu during recording. You can only stop recording after exiting the menu. Display icons are not recorded.

### To start recording:

1. Briefly press the record button (11).
2. The Photon will start recording. "REC" will be displayed at the top left corner of the display. The record timer will also start. Elapsed recording time is displayed at the bottom right of the display.
3. To stop recording, press the record button again. The record timer will stop.

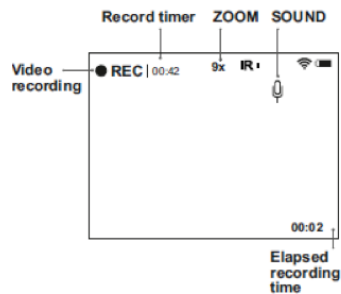

**Note:** the maximum duration of a recorded file is seven minutes. After this time, a video is recorded in a new file. The number of recorded file is limited by the capacity of the unit's internal memory. Approximately 5 hours of video only can be saved on the internal memory.

## Photo Mode

Photo mode allows for image capture of what is seen on the display. When the Photon is in photo mode, the  (camera) icon is shown on the display.

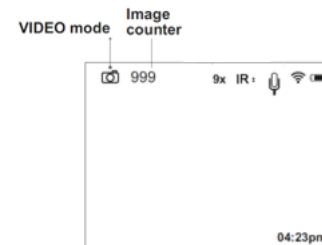

### To take a photo:

1. Briefly press the record button (11).
2. The Photon will save a jpeg image of the current view on the display.
3. The number of available photos left is displayed on the top left of the display.



**Note:** Sound is not recorded in photos.

## Review Mode

Review mode is designed to playback photo and video files saved on the internal memory. When the Photon is in review mode, the display always shows the last recorded file. When in Review mode the  (picture) icon will be shown on the display if a photo is being displayed and the  (video) icon will be shown if a video is being display.

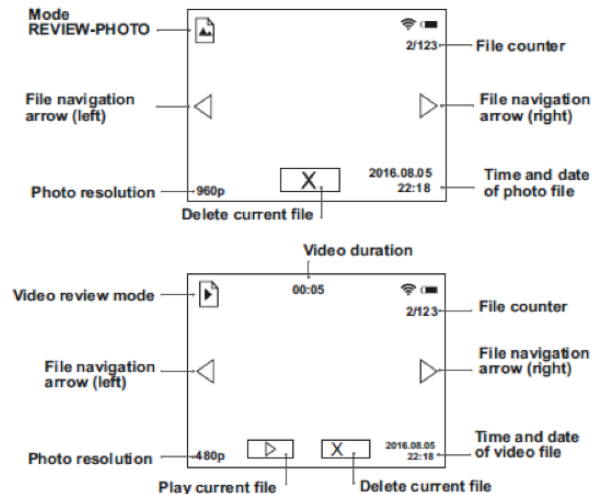

## To navigate files:

1. To navigate to the next file to the left, rotate the controller (3) counterclockwise.
2. To navigate to the next file to the right, rotate the controller clockwise.

## To play a video file:

1. When the desired video file is on the display, press the record button (11) to start playing. The video length countdown timer will start.
2. To pause the video, press the record button again. The pause indicator will appear at the bottom in place of the play indicator. Also the video length countdown timer will stop.
3. To resume play, press the record button again.
4. To return to the start of the current video file, rotate the controller (3).
5. To review the next file, press the record button.

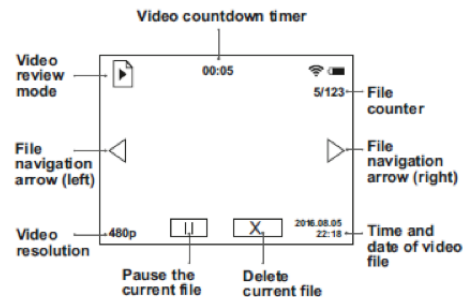

### To delete files:

1. When the desired video file is on the display, press the on/off button (4).
2. The display will show a yes and no option.
3. To select yes, press the controller (3).
4. To select no, press the on/off button (4).

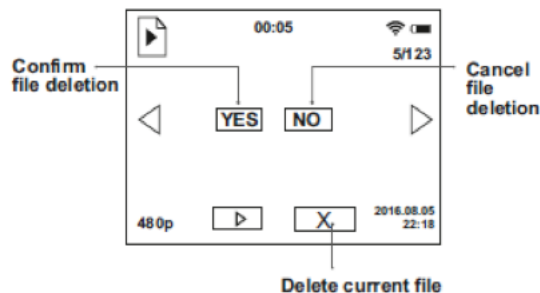

**Note:** During file review some control functions are not available such as menu, zoom control, and IR illuminator control. If the IR was on, it will turn off when entering review mode. The IR illuminator power level is saved and will return to the same power upon exiting review mode.

## MENU

The Photon RT menu system allows access to further features, functions, and customization options. The menu system consists of the following:

- Selection of reticle color
- Wi-Fi setup
- Recording resolution
- Date and time setup
- Sound record activation
- Selection of reticle shapes
- One shot zeroing
- About device

### To open the main menu system:

1. Press the controller (3) for 3 seconds. The menu icons will appear on the left of the display.
2. Rotate the controller counter clockwise to move menu selection down or left.
3. Rotate the controller clockwise to move menu selection up or right.
4. To enter the submenu function, briefly press the controller.
5. To exit the menu, press the controller for two seconds or wait 10 seconds to exit automatically.

### Selection of Reticle Color

Reticles colors can be changed between black, white, red, or green. To change reticle color:

1. Enter the submenu by selecting the reticle color icon, , with the controller (3).
2. Rotate the controller to select the required reticle color: black (B), white (W), red (R), or green (G). Press the controller to confirm your choice.
3. To exit the menu, keep the controller pressed for two seconds or wait 10 seconds to exit automatically.

**Note:** Reticle color is saved and will be same color next time the unit is turned on.

### Wi-Fi Setup

Wi-Fi function allows for external devices such as smartphones to connect to the Photon via the Pulsar Stream Vision App. By using the Pulsar Stream Vision App, the Photon RT's features can be controlled through your smart device. Your smart device can also display live video from your Photon RT. Pulsar Stream Vision app must be downloaded first through the Apple® Store or Google® Play Store. Further guidelines on the Stream Vision app are provided in the individual booklet or on [www.pulsarnv.com/streamvision](http://www.pulsarnv.com/streamvision).

#### To turn on Wi-Fi:

1. Do a short press of the on/off button (4).
2. The Wifi icon will appear at the top right of the display. This indicates wifi is on.
3. When the icon is not visible on the display, this indicates wifi is off.
4. Pressing the on/off button again will turn the wifi off.



Wi-Fi setup allows you to set a password for the access point. This password is used to connect an external device (smartphone for example) to the Photon RT.

#### To setup Wifi password:

1. Enter the submenu by selecting the lock icon, .
2. A password will appear on the display, default password is **12345**.
3. Rotate the controller to set your desired password. Clockwise rotation of the controller will increase the value. Counterclockwise rotation will decrease the value. To switch between digits, briefly press the controller.
4. To save the password and exit password submenu, hold down the controller for longer than one second.

Wi-Fi setup also allows users to set access levels. This feature allows users to restrict access to others to only see video streaming from the device and not have the ability to access the device's functions.

#### To set access levels:

1. Enter the submenu by selecting the access icon, , with the controller (3).
2. Select access level Owner, or the house icon, . This gives Stream Vision users connected to your device complete access to all the device's functions.
3. Select access level Guest, or the door icon, . This gives Stream Vision users connected to your device access only to the video stream for remote viewing.

### Recording Resolution

The recording resolution of the Photon RT can be changed for video and photos. Lower resolution video and photos require less memory and will provide longer video record times, or storage of more photos.

#### Video mode available resolution:

- 320x240
- 640x480

#### Photo mode available resolutions:

- 320x240
- 640x480
- 1280x960

#### To change resolution:

1. Enter the submenu by selecting the resolution icon, , with the controller (3).
2. The options: 240 (320x240), 480p (640x480), and 960p (1280x960) will be shown on the display.
3. Rotate the controller to the desired resolution and press the controller to confirm the selection.

**Note:** The resolution is displayed in the REVIEW mode. The resolution selected is also saved. Next time the Photon RT is turned on, the same resolution is used for recording.

#### Date and Time Setup

This menu options allows the user to set the current date and time and the time format. The current time setting is shown on the display. The date will only be shown as a date/time stamp for recorded photos and videos.

#### To change date and time:

1. Enter the submenu by select the clock icon, , with the controller (3).
2. The date format is displayed as :yyyy/mm/dd (2017/02/12).

3. Rotate the controller to select the desired value. Clockwise rotation will increase the value and counterclockwise rotation will decrease the value. To move to the next digit, press the controller.

4. To save the date, press and hold down the controller for more than one second. The display will next show time setup.

5. The time format is display as “format mm/hh” (24 06:51).

6. Rotate the controller to select the required time format – 24/AM/PM. Press the controller to select the desired time format.

7. To set the hour value, rotate the controller. Clockwise rotation will increase the value and counterclockwise rotation will decrease the value.

8. To set the minute value, press the controller. Rotate the controller to select the minute value.



9. Press and hold down the controller for more than one second to save the time settings and exit the menu.

#### Sound Record Activation

This menu option allows you to activate/deactivate sound recording. Sound recording is only used in video record mode.

#### To turn sound recording on and off:

1. Enter the submenu by selecting the microphone icon, , with the controller (3).
2. Rotate the controller to select yes to turn on sound recording. Select no to turn off sound recording.
3. Press the controller to confirm the selection.

**Note:** When sound recording is activated, the microphone icon, , will appear on the display. When sound recording is turned off, the crossed out microphone icon, , will appear on the display. The selection is saved. Next time the unit is turned on, the display will show the last saved setting.

### Reticle selection

The Photon RT is equipped with 6 reticle options the user can select based on their hunting needs and preference.

#### To select the reticle:

1. Enter the submenu by selecting the reticle icon, , with the controller (3).
2. Rotate the controller to change the reticle designs shown on the display.
3. Confirm the reticle selection with a short press of the controller.
4. To exit the menu, keep the controller pressed for two seconds or wait 10 seconds to exit automatically.

**Note:** When using digital zoom, the reticle does not change size. Reticle selection is saved and will be same reticle design next time the unit is turned on.

### One Shot Zeroing

The Photon RT is equipped with the "one shot" zeroing feature. Zeroing should be done safely on a firing range. It is recommended to zero the Photon RT in the same operating temperatures. Always use the same ammo manufacturer and grain, any change in ammo may require the Photon RT be re-zeroed.

#### To zero:

1. For improved ease of use, mount the rifle in a benchrest.
2. Set a target at a distance of 100 yards.
3. Turn on the Photon RT and adjust focus to obtain a clear picture of the target.
4. Aim at the center of the target. Take one shot at the target. Do not move the rifle and ensure the sight remains aimed at the same central point on the target.
5. Examine the target and determine if the aiming point is aligned with the point of impact.
6. To make adjustment, open the menu system by pressing and holding the controller (3).

7. Rotate the controller to select the zero icon, , press the controller to start the zeroing process.

8. Next, an auxiliary cross (C) will appear in the center of the display. On the left side of the display X/Y coordinates will appear. X/Y coordinates indicate the location of the auxiliary cross on the display.

9. By keeping the reticle aimed at the center of the target (original aiming point), rotate the controller to move the auxiliary cross to match the point of impact. To switch between horizontal (windage) and vertical movement (elevation) push the controller once. Direction for the coordinates switches from left/right arrows (windage) to up/down arrows (elevation).

10. Next, press and hold the controller button to save the reticle adjustment. Message "ok" confirms the adjustment has been saved. The reticle will now move to the point of impact.

11. Confirm zero by firing another shot. The reticle and point of impact should now match.

**Note:** Do not turn off the sight before zero settings are saved. Step 10 above must be performed in order to save the zero adjustment, otherwise your settings will be lost. Total windage and elevation travel range of the reticle is +/- 50 clicks. Click values are approximately .1 mil or .34 MOA

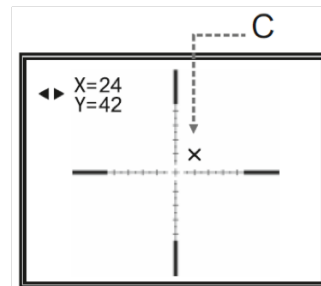

## About Device

This menu option shows the following service information about your Photon RT rifle scope such as the serial number and software version.

1. Enter the submenu by selecting the reticle color icon,  , with the controller (3).

Name: Photon RT (name of unit)

Serial: 20119307 (serial number)

FW: 12.34.567 (software version)

HW: MNV001 (hardware version)

## Accessories

The Photon RT is outfitted with a weaver accessory rail (7) which allows you to attach accessories such as IR flashlights, lasers, or other weapon mountable accessories.

### Compatible Photon RT accessories:

- SM19075 – Sightmark IR-805 Compact Infrared Illuminator
- SM27000 – Sightmark SS1000 IR Illuminator
- PL79071 – Pulsar 805 IR Illuminator
- PL79076 – Pulsar 940 IR Illuminator
- PL79074 – Pulsar X850 IR Illuminator
- PL79072 – Pulsar L-808S Laser IR Illuminator
- PL79075 – Pulsar L-915 Laser IR Illuminator

- PL79133 – Pulsar AL-915 Laser IR Illuminator
- PL79117 - Pulsar DNV Battery Pack
- PL79167 - Pulsar DNV Battery Double Pack

## MAINTENANCE

Proper maintenance of the Sightmark Photon RT is recommended to ensure longevity. Attempts to disassemble or repair the rifle scope will void the warranty. It is recommended that when the rifle scope becomes dirty that it is wiped down with a dry or slightly damp cloth. Blow dirt and debris off all optics and then clean lenses with a lens cleaning cloth. To remove oils or dried water spots, apply a small amount of denatured alcohol to a lens cloth or cotton swab. Clean the surface of the lens and let dry. Finally use your breath to clean the lens once more. No further maintenance is required.

## WARNING

The Ranger RT is a digital night vision rifle scope, this allows the unit to also be used during the daytime without damaging the unit. However, it is not recommended to point the Ranger RT at bright light sources such as the sun. Using the unit from cold to warm conditions will cause condensation to form on the lenses. It is recommended to keep the unit in its carry case for 2 to 3 hours when transitioning from cold to warm temperatures.

**WARNING!**

- DO NOT submerge the unit into water.
- DO NOT leave the unit in direct sunlight or rain.
- DO NOT expose the unit to high heat as this may damage the unit.
- DO NOT cover the IR heat sink (5). Keep it clean to insure proper performance of the long range IR illuminator.
- DO NOT connect inappropriate equipment (i.e. headphones) to the video output. This may disable the unit.
- Up to seven light or dark spots on the LCD display is acceptable and not considered defective.

## STORAGE

Always store the unit in its carrying case or on a rifle in a dry, well ventilated space. For prolong storage , remove the batteries

## TROUBLESHOOTING

Never ship back a product without getting proper authorization beforehand. Doing so could result in losing the product due to a multitude of reasons, i.e. sending it to the wrong address and other problems associated with unexpected packages.

### **The unit will not turn on:**

1. Check the polarity of the batteries. Reinstall the batteries if necessary.
2. Clean the battery compartment contacts with denatured alcohol and a cotton swab.
3. Install fresh batteries.

### **The IR illuminator will not turn on:**

1. Adjust the brightness of the IR, noting brightness indication on the display. Adjust the display brightness. If no IR light is being detected the unit may need to be returned for service.

### **The image is dark:**

1. Make sure the lens caps on the objective lens is opened and the IR illuminator is on. Adjust the display brightness and the IR illuminator brightness accordingly to obtain a bright, clear image. For best imaging using performance, if using at night use with the lens cap open. If using in daylight use with lens cap closed.

### **There are light or black dots on the display:**

1. The presence of dots on the display is caused by sensor production technology and is not a defect. No action is required.

### **The unit does not operate on external power:**

1. Make sure the power supply is providing output voltage.
2. Check that the power bank is charged. Charge if necessary.
3. Check that the USB cable is plugged in to both the Photon or power supply.

### **The image is flickering:**

1. This is common if the unit is viewing or pointing in the direction of a bright light source. Cease viewing the bright light source immediately. If flickering in normal dark conditions the unit may need to be returned for service.

The image is not in focus:

1. Make sure there is no dust or condensation covering the objective lens or eyepiece.
2. Adjust the focus ring near the objective lens to adjust focus for different viewing distances.
3. Make sure to adjust the diopter setting on the eyepiece for your specific vision.

### **The reticle will not remain zeroed:**

1. Check that the scope is mounted securely to the firearm.
2. Be sure to use the same type of ammo manufacturer and grain as when the scope was initially zeroed.
3. If the operating temperatures are different than when you zeroed, this can cause a small shift in point of impact.

### **No Wi-Fi signal or erratic signal:**

1. The Photon is beyond reliable Wi-Fi range or there are obstacles between the unit and the signal receiver. Place the Photon in line of sight of the Wi-Fi signal.







SIGHT  MARK®