

SLX[®] PROVEN RELIABILITY AND VALUE

SLX[®] 1x**MICROPRISM**

MANUAL

For Patent Information go to <https://goo.gl/2z62aS>

 **PRIMARY ARMS[®]**

Thank you for choosing this Primary Arms optic.

If you have any questions about your new optic or any of our other products, visit us at www.primaryarmsoptics.com, email us at info@primaryarmsoptics.com, or give us a call toll-free at 855-774-2767. The customer service team at our headquarters in Houston, Texas will respond promptly.

If you have any problems with a Primary Arms product, we urge you to contact us immediately and let our customer service professionals handle the situation for you. There is no need to return your optic to the retailer.

*View back cover for lifetime warranty information.



TABLE OF CONTENTS

Page 3	Introducing: Primary Arms SLx MicroPrism Scope
Page 3	Features
Page 3	Achieving a Clear Reticle Picture PLEASE READ THIS FIRST
Page 4	How to Set Reticle Illumination
Page 4	Zeroing
Pages 5-6	SLx 1x MicroPrism Scope Diagram
Page 7	Mounting Options
Page 8	Battery Compartment
Page 9	Specifications & Battery Life
Page 10	Lens Care

PRIMARY ARMS SLx 1x MICROPRISM

The 1x MicroPrism scope is the smart alternative to red dot sights, providing fast target acquisition using the etched ACSS® reticle that works with or without illumination. Like reflex optics, the SLx 1x MicroPrism is built for agility in close quarters, featuring an ultra-long eye relief 'usable range', which extends from 2" all the way out to 7". The quick adjust diopter ring keeps the reticle sharp in the generous field of view, providing a crisp sight picture in all lighting conditions. The 1x MicroPrism uses standard mini prism mounts and includes all hardware necessary to mount the optic at 8 different mounting heights.

SLx 1x MICROPRISM SCOPE FEATURES

- Thirteen Brightness Settings: NV1, NV2 & NV3 are NightVision compatible. Highest settings are Daylight Bright.
- Accommodation for Anti-Reflection Devices (ARD) (Sold Separately).
- Includes AutoLive battery-saving motion-sensing on/off technology.
- Hardware included for 8 different mounting heights.
- Aluminum Alloy Main Body with Hard Coat Anodizing.
- Fully Nitrogen Purged, IP67 Waterproof and Dust Proof.
- Backed by Our Lifetime Warranty.

HOW TO ACHIEVE A CLEAR RETICLE PICTURE

Setting the diopter ring at the rear of the eyepiece is the critical first step to successful precision shooting. Looking at a featureless light background like a clear blue sky or blank wall, the reticle should appear sharp and crisp. If it does not, you need to make adjustments by turning the ring. Look at the scope with quick glances and adjust until the reticle is clear at first glance. This is a one-time adjustment. Because everyone's eyes are different, the ideal adjustment will vary from person to person.

HOW TO SET RETICLE ILLUMINATION

Your reticle comes with a total of thirteen brightness settings, three of which are night vision compatible. The night vision settings are unable to be seen by the naked eye and can only be viewed through a separate night vision device. The indicator triangle makes it easy to determine your brightness setting. The illumination knob can be turned infinitely in either direction, ensuring the shortest path to your desired illumination regardless of the current illumination setting. To turn illumination off, simply return the dial to the off (0) position.

ZEROING

The optic is delivered in a centered position. Normally, this means that only small adjustments are necessary, providing that the base is properly aligned. Work your way to “zero” by adjusting each turret only a few clicks at a time. To adjust windage and elevation turn them as follows:

- a. To move the point of impact to the right, turn the windage adjustment screw counterclockwise.
- b. To move the point of impact to the left, turn the windage adjustment screw clockwise.
- c. To move the point of impact up, turn the elevation adjustment screw counterclockwise.
- d. To move the point of impact down, turn the elevation adjustment screw clockwise.

Every click will shift the position of the reticle by 1 MOA. The maximum total adjustment range for both windage and elevation is 120 MOA. If you suddenly encounter resistance, do NOT try to force the screw further, this can break the mechanism and render the sight unable to zero. Confirm zero by firing at least three shots at a zeroing target. After initial firing, check that the optic and mount are secure on your firearm. Check your impact points on the target to confirm accuracy and repeat until you are satisfied that the point of aim and the point of impact coincide at your desired range.

Optional risers allow you to customize optic height.

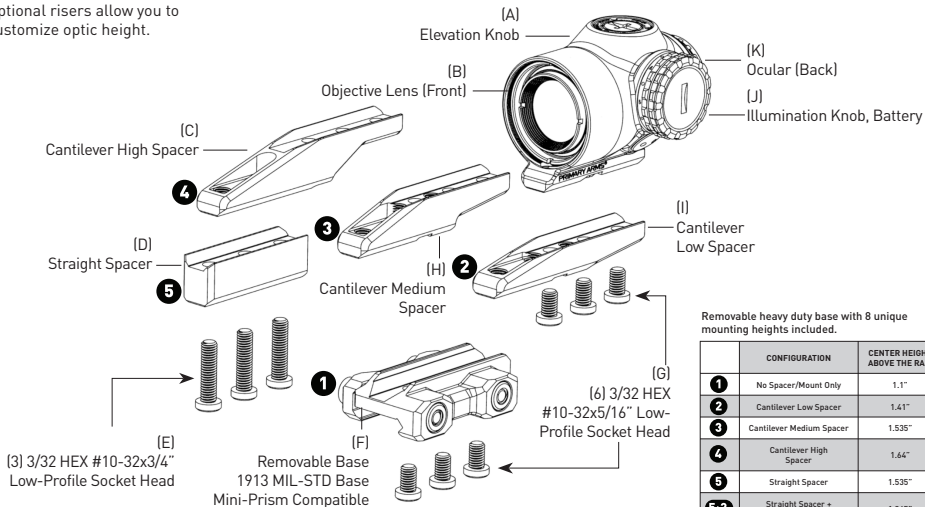

Removable heavy duty base with 8 unique mounting heights included.

	CONFIGURATION	CENTER HEIGHT ABOVE THE RAIL
1	No Spacer/Mount Only	1.1"
2	Cantilever Low Spacer	1.41"
3	Cantilever Medium Spacer	1.535"
4	Cantilever High Spacer	1.64"
5	Straight Spacer	1.535"
5+2	Straight Spacer + Cantilever Low Spacer	1.845"
5+3	Straight Spacer + Cantilever Medium Spacer	1.97"
5+4	Straight Spacer + Cantilever High Spacer	2.075"

Note: All these heights are measured using the included mount and may vary if using aftermarket mounts.

The included mount and risers enable the user to place the optic at different heights to make it usable on most platforms. The lowest mounting option will place the centerline of the optic at about 1.1" above the rail. The mount paired with the low spacer will place the center line at 1.41", the medium spacer will place it at 1.535", and the high spacer will place it at 1.64". The highest mount has an extended overhang to allow the user to place the optic above most rear iron sights on standard AR style firearms.

1.1"

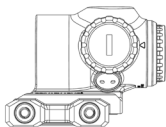

No Spacer/Mount Only

1.41"

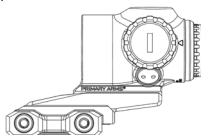

Cantilever Low Spacer

1.535"

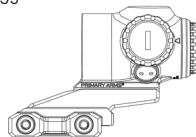

Cantilever Medium Spacer

1.64"

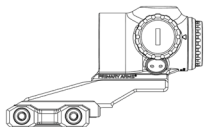

Cantilever High Spacer

1.535"

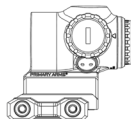

Straight Spacer

1.845"

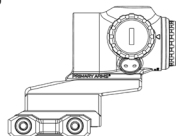

Straight Spacer +
Cantilever Low Spacer

1.97"

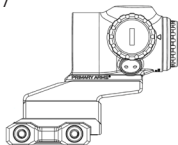

Straight Spacer +
Cantilever Medium Spacer

2.075"

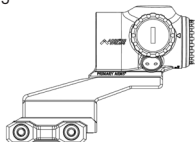

Straight Spacer +
Cantilever High Spacer

FOR EXAMPLE: 5+2 IS STRAIGHT
SPACER + CANTILEVER LOW SPACER AT
1.845" HEIGHT

MOUNTING OPTIONS

The included 1913 MIL STD base positions the centerline of the 1x MicroPrism Scope 1.41" above the receiver rail, the same height as standard AR-15 iron sights. With the base removed, the underside of the optic body is machined to be compatible with industry standard mini prism-mounts. When mounting any base to the 1x MicroPrism Scope, the recommended torque the 10-32 screws to 25-30 in-lbs. Do not overtighten them!

A black security type screw is also located on the underside of the optic, this is the nitrogen gas purge port. Do not attempt to adjust that screw, or the nitrogen may vent from inside the optic, compromising function. For the same reason, do not attempt to adjust the spring cover also located under the optic on the left side.

The crossbolt located on the removable base uses a T25 Torx and should be tightened to 55-60 in-lbs. applying blue thread locker to the crossbolt threads.

BATTERY COMPARTMENT

The 1x MicroPrism Scope uses a single CR2032 battery. The battery cap is located on the left side and unscrews counterclockwise using a quarter or other coin. The positive (+) side of the battery faces out towards the cap. Rechargeable batteries are not recommended and can potentially damage the electronics.

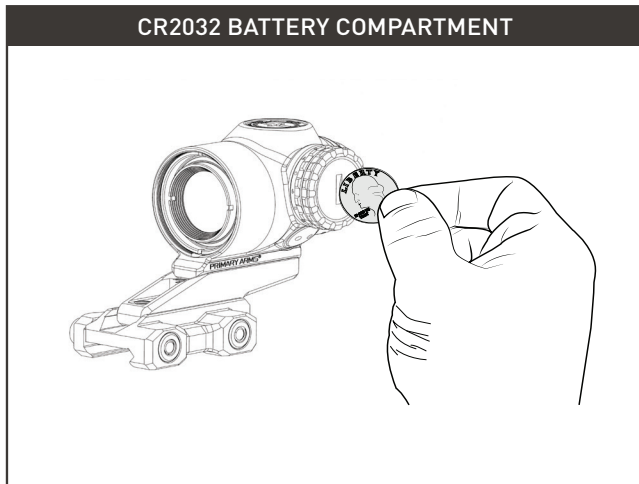

SLx 1x MicroPrism Scope Specifications

Magnification: 1x	Click Value: 1 MOA	Total Elevation Adjustment: \geq 120 MOA
Objective Lens Diameter: 17 mm	Field of View: 76.5 feet @ 100 yards *	Total Windage Adjustment: \geq 120 MOA
Eye Relief: 3.6" (Usable Range: 2" to 7")	Weight (with Battery, w/o Lens Covers): 7.0 oz	Lifetime Warranty
Exit Pupil: 16.2mm	Length (w/o Lens Covers): 2.48"	

Specifications may vary and are subject to change without notice.

* Optimum FOV with 3.6 in. Eye Relief

BATTERY LIFE (AUTOLIVE®)

We put honesty at the forefront of our work, which is why we won't mislead you with unrealistic claims about battery life. All of our optics use the latest illumination and emitter technologies to ensure you get the maximum runtime possible, but actual battery life will depend on factors like your brightness setting, battery quality, and environmental factors. On low settings, many optics can last months or years without dimming, but if you're maxing out your brightness and leaving it on, you can expect reduced runtime.

To help you get the most from your battery, this optic features our proprietary AutoLive motion-sensing illumination technology. By reducing the optic's output when not in-use, AutoLive can extend your battery's life to its maximum potential value. No additional setup is needed: AutoLive is active whenever illumination is on.

LENS CARE

Please do not use any organic solvent such as alcohol or acetone on your optic. First, blow dust or any foreign objects off of the lens. Then, use a soft cotton or microfiber lens cloth to clean any fingerprints or smears off the lens. Alternatively, you may use a piece of professional lens paper for further cleaning, if necessary.



WARNING: Always ensure your firearm is unloaded (chamber empty and magazine removed) before installing optics or accessories.



WARNING: Improper installation of firearm parts or accessories may result in death or serious personal injury. If you are not properly trained in the installation of these parts, have them installed by a gunsmith or armorer.

REMEMBER: THE FOUR RULES OF FIREARMS SAFETY

1. Treat every firearm as if it were loaded.
2. Never let your muzzle cover anything you are not willing to destroy.
3. Keep your finger off the trigger until your sights are on target.
4. Be sure of your target and what is behind it.



LIFETIME WARRANTY

Your Primary Arms SLx MicroPrism Scope is covered by the Primary Arms Lifetime Warranty. If a defect due to materials or workmanship, or even normal wear and tear has caused your product to malfunction, Primary Arms will either repair or replace your product. You can find more details about our lifetime warranty at www.primaryarmsoptics.com.

Email: info@primaryarmsoptics.com
Toll-free at 855-774-2767
www.primaryarmsoptics.com

For more information on these optics, go to:
<http://primaryarmsoptics.com/product-category/prism-scopes/>