

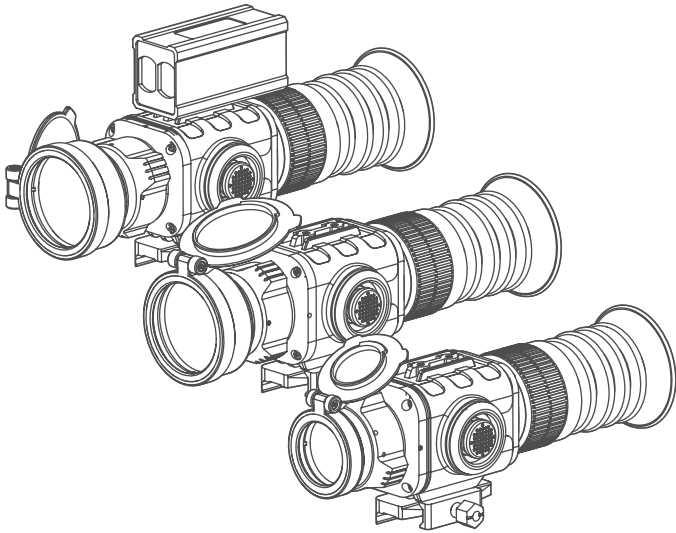

AGM
GLOBAL
VISION



PYTHON-MICRO

THERMAL IMAGING RIFLESCOPE

USER MANUAL

© 2019 AGM Global Vision. All rights reserved worldwide.

This documentation is subject to change without notice.

No parts of this manual, in whole or in part, may be copied, photocopied, translated, or transmitted by any electronic medium or in machine-readable form without the prior written permission of AGM Global Vision.

If you have questions that are not covered in this manual, or need service, contact AGM Global Vision customer support for additional information prior to returning a product.

AGM Global Vision

173 West Main Street

PO Box 962

Springerville, AZ 85938

Tel. 928.333.4300

Fax 480.393.4882

support@agmglobalvision.com

www.agmglobalvision.com

EXPORT INFORMATION

Buyer acknowledges that all products supplied by AGM Global Vision are subject to U.S. export control laws, including, but not limited to, the Export Administration Regulations, the International Economic Emergency Powers Act, and various U.S. embargoes and sanctions. AGM Global Vision products may not be exported, re-exported, or transferred contrary to U.S. export control laws. In particular, AGM Global Vision products may not be exported, re-exported, or transferred to prohibited countries, individuals, organizations, or entities, including but not limited to those individuals and entities listed on the List of Specially Designated Nationals and Blocked Persons administered or maintained by the U.S. Office of Foreign Assets Control ("OFAC"), the various lists maintained by the Bureau of Industry and Security of the Department of Commerce, and the U.S. State Department and Buyer represents and warrants that neither Buyer nor any of its officers, directors, or employees are on such lists. Distribution or resale by Buyer to such countries, individuals, organizations, or entities is expressly prohibited. Buyer has and will maintain a positive process to ensure compliance with this Section.

LIST OF CONTENTS

TITLE	PAGE
Safety Summary	4
1. GENERAL INFORMATION	6
1.1 System Description	6
1.2 Main Features	6
1.3 Main Parts and Components	7
2. OPERATING INSTRUCTIONS	8
2.1 Installation and Mounting	8
2.2 Controls and Indication	11
2.3 Operating	22
3. WARRANTY INFORMATION	23
3.1 Warranty Information and Registration	23
4. SPECIFICATIONS	25
4.1 Specifications	25

SAFETY SUMMARY

- Read and follow all instructions
- Read all warnings
- Only use the attachments/ accessories specified by the manufacturer
- All service must be provided by the manufacturer

WARNING:

The proper usage of the device is important for safe exploitation!
Therefore read carefully the present manual!

WARNING:

If the device was left in storage for a longer period of time, before exploitation check its functionality.

WARNING:

Disassembling of the device is prohibited, except in authorized repair centers.

WARNING:

The external optical surfaces should be clean at all times. Touching the optical surfaces with bare hands is not recommended.

WARNING:

Sand and sea water can damage the optical coatings!

WARNING:

Do not point the device directly at the sun!

WARNING:

Image performance is dependent on scenery and atmosphere conditions. Contrast in the same image may vary as a function of the time of day due to the effect of the sun. For example, at sunset objects will have absorbed different levels of heat resulting in greater temperature differences and better contrast.

WARNING:

When left in storage for a longer period of time, batteries have to be removed and stored in polyethylene bags to prevent contact with metal. (It is recommended to recharge the batteries every two to three months.)

WARNING:

When carrying or transporting the device, put the protective lens cap!

WARNINGS:

Condensation can cause fogging of the optical surfaces! Condensation occurs when the temperature or humidity changes as follows:

- When moving the device from cold to warm place or vice versa;
- In places with high humidity.

When equalizing the temperature of the device with the environmental, the condensation disappears. Use the towel to remove moisture.

WARNING:

Clean the lens surfaces with the Lens Cloth or with the napkin!

WARNING:

The IR light from the laser emitter of the Python-Micro TS50LRF range finder is invisible to the naked eye. However, the light can be detected by all night vision devices (NVD). To reduce the risk of detection, avoid prolonged activation of the laser.

The IR light is more detectable by other NVDs when used in smoke, fog and rain. Avoid prolonged activation of the IR laser in these conditions.

WARNING:

NEVER LOOK INTO THE LASER BEAM!

LEGAL NOTICE

Before attaching to weapons, check the regional legal regulations in the area of application. The attachment to a weapon is always the sole responsibility of the user.

1 GENERAL INFORMATION

1.1 SYSTEM DESCRIPTION

The AGM Python-Micro TS35, Python-Micro TS50, and Python-Micro TS50LRF are the compact thermal imaging scopes developed for 24 hours operation under any weather and environmental conditions. Two modifications of objective lenses allows to choose perfect unit for your needs where 35 mm lens designed for short range shooting, while 50 mm lens model will be great for medium range missions.

Powered with two CR123 batteries the AGM Python-Micro gives up to 5 hours of continues work. An external 5V power bank (battery pack) can be easily connected via an USB connector for a significant increase of operating time.

The Python-Micro TS50LRF model is equipped with a built-in laser range finder. The laser range finder is designed to determine the exact distance between the observer and the target. Measurement results are displayed on display of the thermal riflescope.

1.2 MAIN FEATURES

- Lightweight and compact design
- Easy to operate device
- Automatic or manual (silent) calibration
- High resolution OLED display
- Electronic accuracy correction
- Waterproof, shockproof
- Powered by two standard CR123A batteries
- External power supply capability

1.3 MAIN PARTS AND COMPONENTS

The Python-Micro is shown in Figure 1-1. The ITEM column of Table 1-1 indicates the number used to identify items in Figure 1-1.

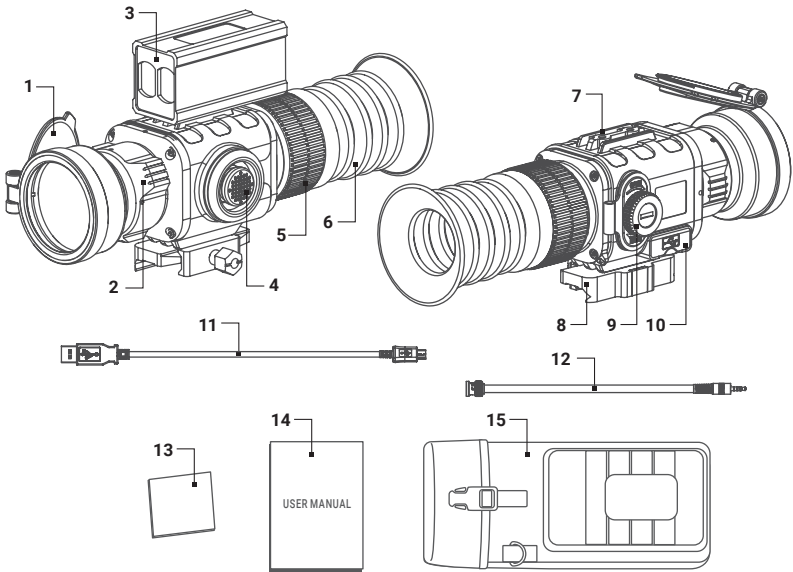

FIGURE 1-1. PYTHON-MICRO TS50 MAIN PARTS AND COMPONENTS
TABLE 1-1. PYTHON-MICRO MAIN PARTS AND COMPONENTS

ITEM	DESCRIPTION	ITEM	DESCRIPTION
1	Lens cover	9	Battery compartment cap
2	Objective focus ring	10	USB and Video connectors (closed with a cover)
3	Laser range finder (Python-Micro TS50LRF model only)	11	USB cable
4	Operation joystick	12	Video cable
5	Eyepiece focus ring	13	Lens tissue
6	Eyecup	14	User manual
7	Extension interface	15	Carrying bag
8	Mount		

2 OPERATING INSTRUCTIONS

2.1 INSTALLATION AND MOUNTING

2.1.1 UNPACKING

The following steps must be completed prior to each mission.

1. Open the carrying bag, remove the device, and verify that all components are accounted for.
2. Inspect the device for any obvious evidence of damage to the optical surfaces, body, operation button, etc. Ensure that all optical surfaces are clean and ready for use. Clean all optical surfaces with a lens tissue.

2.1.2 BATTERIES INSTALLATION

Turn the battery cover knob clockwise until stop and remove the cover from battery compartment (see the Figure 2-1, OPEN position). Install two CR123A batteries in opposite polarity direction (Figure 2-2).

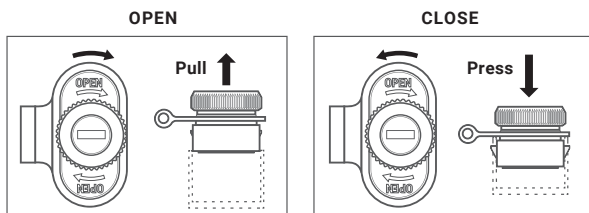

FIGURE 2-1. BATTERY COMPARTMENT

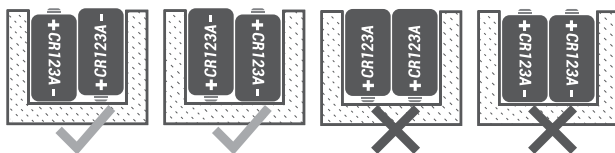

FIGURE 2-2. BATTERY POLARITY

Turn the battery cover knob counterclockwise until stop. The latches from both sides of the cover will pull out. Replace the battery cover and press it until its clicking position. (see the Figure 2-1, CLOSE position). Make sure the cover is closed on both sides. Battery charge level is displayed on the status bar (Figure 2-3)

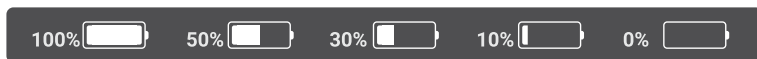

FIGURE 2-3. BATTERY STATUS BAR

WARNING:

Do not use rechargeable batteries since their use causes inaccurate battery level indication and possible disconnection during operation.

NOTE:

Please do not use batteries of different types or batteries with various charge levels.

2.1.3 INSTALLING THE PYTHON-MICRO ON A PICATINNY/WEAVER RAIL

The Python-Micro can be attached to the Picatinny-style rail. To do this, loosen the fixation screw of the mount (Figure 2-4, A). Place the scope onto the Picatinny rail, and verify that the mount aligns with the rail. Tighten the fixation screw.

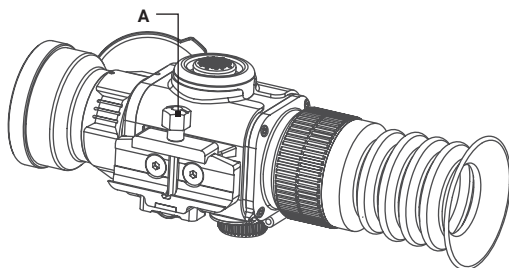

FIGURE 2-4. INSTALLING THE PYTHON-MICRO

2.1.4 VIDEO CABLE CONNECTION

Video cable serves for the connection with an external display monitor. Install the cable refer to Figure 2-5.

Open the cover of the Python-Micro connectors. Plug the cable to the mini-jack 3.5mm connector.

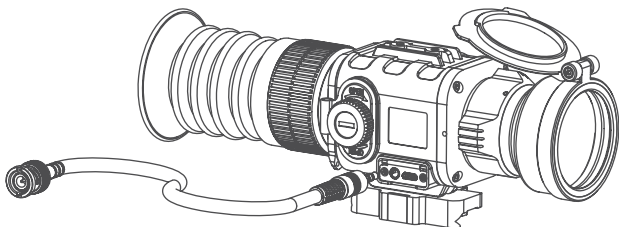

FIGURE 2-5. CABLE CONNECTION

2.1.5 USB CABLE CONNECTION

The external power source can be used for Python-Micro extended operational time.

Connect the external battery as follows (refer to Figure 2-6):

1. Open the cover of the Python-Micro connectors.
2. Plug the USB cable to the micro-USB connector of the Python-Micro. Plug the other end of the cable to the external battery.

The USB cable also enables updating the device's firmware to the latest version. Contact your local distributor for update service.

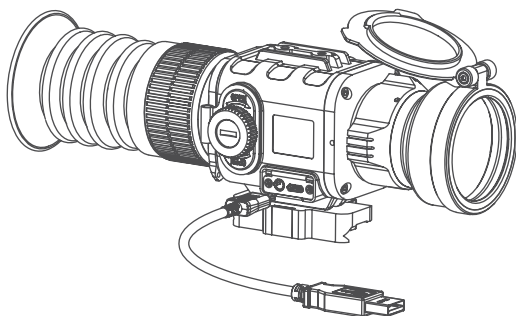

FIGURE 2-6. EXTERNAL BATTERY CONNECTION

2.2 CONTROLS AND INDICATION

2.2.1 CONTROLS

ATTENTION:

The main operations are performed through the operation joystick.

The Python-Micro controls are shown in Figure 2-7. The ITEM column of Table 2-1 indicates the number used to identify items in Figure 2-7.

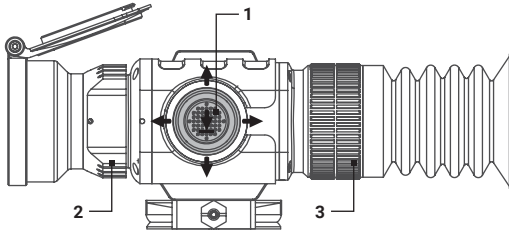







FIGURE 2-7. CONTROLS

ATTENTION:

Turn off the device after usage, otherwise you can permanently damage the batteries!

TABLE 2-1. CONTROLS

ITEMS	CONTROLS	OPERATING MODE	FIRST SHORT PRESS	LONG PRESS
1	 Joystick Button Push	Real time image	Bring out quick menu	ON / OFF
		Quick menu	NUC	
		Main menu	Confirm selection	
		LRF Mode		
	 Joystick Up	Real time image	Bring out quick menu	Enter main menu
		Quick menu	Change parameters	
		Main menu	Change parameters	
		LRF Mode	Distance reading	
	 Joystick Down	Real time image	Bring out quick menu	NA
		Quick menu	Change parameters	
		Main menu	Change parameters	
		LRF Mode	Distance reading	
	 Joystick Left	Real time image	Bring out quick menu	NA
		Quick menu	Switch function	
		Main menu	Select Setting Options	
		LRF Mode	Distance reading	
 Joystick Right	Real time image	Bring out quick menu	NA	
	Quick menu	Switch function		
	Main menu	Select Setting Options		
	LRF Mode	Distance reading		
2	Focus Ring	Focuses the objective lens for the sharpest image		
3	Eyepiece Focus Ring	Adjusts the eyepiece diopter		

2.2.2 STATUS BAR

The status bar is located in the lower part of the display (Figure 2-8) and shows information about an actual operating status of the sight, including:

1. Color palette: WH (White Hot), BH (Black Hot), C1~C10.
2. Zeroing profile A/B/C/D/E.
3. Rangefinder distance display.
4. Current digital zoom magnification.
5. Battery charge with current level in percent.



FIGURE 2-8. STATUS BAR

2.2.3 QUICK MENU

The Quick Menu allows change of basic settings. Enter the Quick menu with a short press of any button in Up/Down/Left/Right. To toggle between the functions below, press Left or Right button when Quick menu is in display. If select of Zoom, Palette, Brightness, Contrast, Sharpness functions do not take place in 5 second, the information disappear from display.



ZOOM

Press the Up/Down buttons to change digital zoom from 1X, 2X, 4X, and PIP. Picture in inset window under PIP mode is 2X digital zoom.



PALETTE

Basic image mode is "White Hot". Press the Up/Down buttons to select palette C1~C10.



BRIGHTNESS

Press the Up/Down buttons to change image brightness from 0~9.



CONTRAST

Press the Up/Down buttons to change display contrast from 0~9.



SHARPNESS

Select one of the sharpness aside with a short press of Up / Down.



MANUAL(SILENT) CALIBRATION

Close the Lens Cover before calibration.



STADIAMETRIC RANGEFINDER

Python-Micro riflescopes are equipped with a stadiametric rangefinder which allows the user to estimate approximate distance to an object of known size.

You will see on the display: measurement bars, icons of three reference objects and respective distances for the three objects.



FIGURE 2-9. STADIAMETRIC RANGEFINDER

There are three pre-set reference objects:

- Hare** - height 0.3 m
- Wild boar** - height 0.7 m
- Deer** - height 1.7 m

The lower fixed bar under the object automatically appear on display, press the Up/Down buttons to move the upper horizontal bar until the object fits entirely between the two lines. The distance to the object is automatically recalculated as you move the upper line.

Press Left/Right buttons to choose reference object, press Middle button to exit rangefinder mode, range information will not disappear from display automatically.

Distance to the object displays in status bar and a "> <" on reticle suggests the aiming point accordingly.

To select the unit of measurement (meters or yards), go to the respective menu option.



LASER RANGE FINDER (Python-Micro TS50LRF only)

The Python-Micro TS50LRF model is equipped with a built-in laser range finder. When under real time image mode, press right button to enter range finder mode, then press UP/DOWN/LEFT/RIGHT, the corresponding distance of target appears on display.

Press Middle button to exit Laser rangefinder mode.

Range information will not disappear from display automatically.



FIGURE 2-10. LASER RANGE FINDER

Distance to the object displays in status bar and the marks "> <" on reticle suggests the aiming point accordingly.

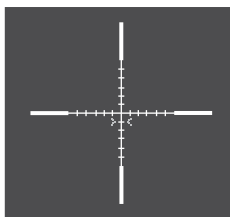

FIGURE 2-11. AIMING POINT MARKS ON THE RETICLE

2.2.4 MAIN MENU

NOTE

Enter the main menu with a long press of the Up button. Press the Left/Right buttons to select between the main menu options.

All menu is displayed in the central area of the image. The reason is the reduced field of view of the day sight by higher magnifications. Reaching a low battery state the device gives a warning in the top left corner of the central area.



EXIT

Press the Up/Down button to Exit, the Main Menu will not disappear automatically.



AUTO NUC

Press the Up/Down button to turn Automatic Non-uniformity Calibration On / Off. In the automatic mode the need for calibration is based on software algorithm, calibration starts automatically. When choose Off, user will do calibration manually by either lens cover(silent without shutter) or press middle button(with shutter). Manual calibration function is in Quick Menu.



OLED BRIGHTNESS

Press the Up / Down buttons to change OLED brightness from -2, -1, 0, 1, 2.



UNIT

Press Up/Down to select units of measurement from Yards and Meters.





DEFECTIVE PIXEL REPAIR

Press Up/Down buttons then close lens cover to repair defective pixel. Defective pixels are found by software algorithm.

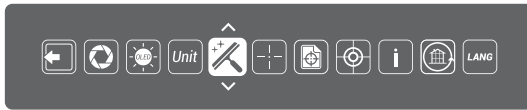

RETICLE

This main menu option allows you to select reticle shape and color. Enter submenu of "Reticle Setup" with a short press of Up/Down and you will see:



Select the desired reticle shape out of the list of 5 reticles with Up/Down. Press Right to move the Reticle Color selection.



Select the desired reticle color Black, White, Red, or Green with Up/Down. Press Right to move to back.



Press Up/Down to return to real time image with the reticle type and color you just chose.

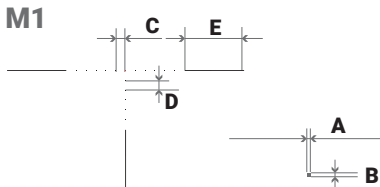

RETICLE PARAMETERS	MOA / CM @ 100 M (35MM)	MOA / CM @ 100 M (50MM)
Section A	0.58 / 2.4	0.58 / 1.7
Section B	0.58 / 2.4	0.58 / 1.7
Section C	5.8 / 2.4	5.8 / 1.7
Section D	5.8 / 2.4	5.8 / 1.7
Section E	37.7 / 156	37.7 / 110.5

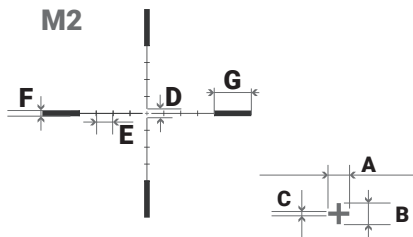

RETICLE PARAMETERS	MOA / CM @ 100 M (35MM)	MOA / CM @ 100 M (50MM)
Section A	2.9 / 12	2.9 / 8.5
Section B	2.9 / 12	2.9 / 8.5
Section C	0.58 / 2.4	0.58 / 1.7
Section D	6.38 / 26.4	6.38 / 18.7
Section E	11.6 / 48	11.6 / 34
Section F	4.06 / 16.8	4.06 / 11.9
Section G	26.68 / 110.4	26.68 / 78.2

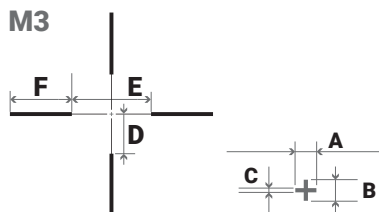

RETICLE PARAMETERS	MOA / CM @ 100 M (35MM)	MOA / CM @ 100 M (50MM)
Section A	2.9 / 12	2.9 / 8.5
Section B	2.9 / 12	2.9 / 8.5
Section C	0.58 / 2.4	0.58 / 1.7
Section D	29 / 120	29 / 85
Section E	58 / 240	58 / 170
Section F	46.11 / 19.08	46.11 / 135.15

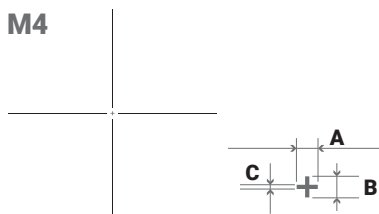

RETICLE PARAMETERS	MOA / CM @ 100 M (35MM)	MOA / CM @ 100 M (50MM)
Section A	2.9 / 12	2.9 / 8.5
Section B	2.9 / 12	2.9 / 8.5
Section C	0.58 / 2.4	0.58 / 1.7



RETICLE PARAMETERS	MOA / CM @ 100 M (35MM)	MOA / CM @ 100 M (50MM)
Section A	0.58 / 2.4	0.58 / 1.7
Section B	0.58 / 2.4	0.58 / 1.7



ZEROING PROFILE

Various profiles can be used when employing the sight on different rifles and when shooting different cartridges. Select one of the zeroing profiles (shown with letters A, B, C, D, E) with short press Up/Down. The name of selected profiles is displayed in the status bar.



ZEROING

To zero your weapon, you need to set a zeroing distance first. You can zero your weapon at any distance range from 1 to 999m. Enter submenu of “zeroing” with a short press of Up/Down and you will see:

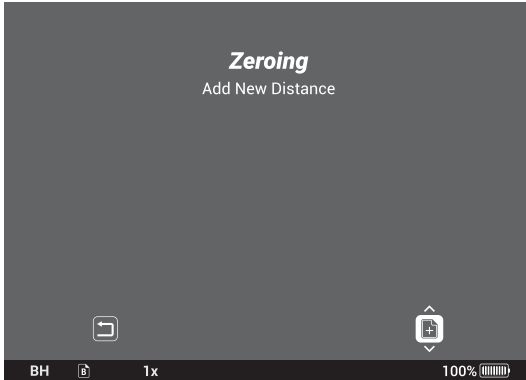

Select profile icon  and press Up/Down. You will see:



Set the value for each digit with press the Up/Down. Switch between the digits with a short press of Left/Right.

To clean the distance press Left/Right to move to , then short press Up/Down.

To confirm distance press Left/Right to move to , then short press Up/Down.

The distance you set shown above the status bar:



To add another distance, press Left/Right to move to profile icon . Select profile icon and repeat the operations described above.

NOTE:

Max number of zeroing distances is 5 for each profile.

OPERATE THE DISTANCE

Press Up/Down on distance icon, you will see:

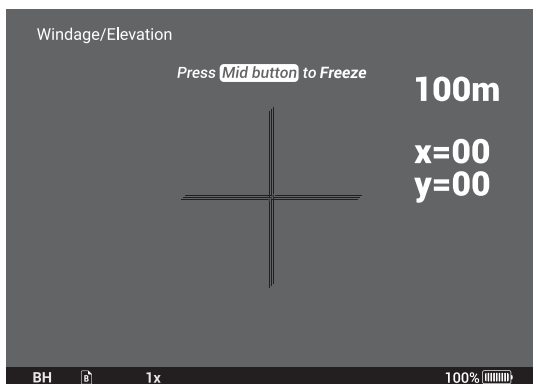

Take a shoot, move Up/Down/Left/Right to make cross center of reticle at point of impact. X, Y will show the distance value you move.

Press middle button to Freeze and you will see:



Save

Press Up/Down to Save, you will see indication:



Back

Press Left, then short press Up/Down to return.



Delete

Press Left/Right, then short press Up/Down to Delete, you will see indication:



NOTE:

In order to get precise ballistic trajectory, zeroing in 3 distances and 3 shots in each distance is recommended, and your shortest distance should be no more than 100 meters.



INFO

This option allows the user to view the following information about the imager.



RESTORE DEFAULT SETTING

Press Up/Down buttons to Restore Default Setting, there will be no further indication.



The following settings will be restored to their original values before changes made by user:

- Zoom
- Image Brightness
- Contrast
- Sharpness
- OLED Brightness



LANGUAGE

This option allows the user to select the interface language.

2.3 OPERATING

2.3.1 TURNING THE DEVICE ON

Open the objective lens cover.

NOTE

The objective lens cover protects the scope from inadvertent exposure to extremely high levels of radiant flux. Never leave the scope without confirming that the objective lens is covered.

To turn the unit on push and hold the operation joystick.

2.3.2 FOCUSING

Adjusts the eyepiece diopter first. Rotate the eyepiece focus ring until the image becomes sharp. Then bring the object into focus. Rotate the front lens until the image becomes clear and sharp.

2.3.3 SHUT DOWN OPERATIONS

To prepare the device for storage:

1. Turn the device OFF. Push and hold the operation joystick.
2. Place the protective cover over the objective lens.
3. Disconnect the cable or adapters (if applicable). Place the protective caps over the connector sockets.
4. Return the scope and any accessories to the case.

2.3.4 MAINTENANCE

1. Gently brush off any dirt from the body of the device using a clean, soft cloth.
2. Moisten the cloth with fresh water and gently wipe down the external surfaces (except lenses).
3. Dry any wet surfaces (except lenses) using another dry, clean, soft cloth.
4. Using a lens brush, carefully remove all loose dirt from the lenses.
5. Dampen a cotton swab with ethanol and slowly, gently wipe down the lenses. Clean the glass surfaces using circular movements, starting from the center of the lens and moving out towards the edge, without touching the lens holder. Change the cotton swab after each circular stroke. Repeat this step until the glass surfaces are clean.

2.3.5 PREPARING FOR EXTENDED STORAGE

To prepare the Python-Micro for extended storage:

1. Remove the batteries.
2. Clean the device and accessories.
3. Place all items into the storage case.

3 WARRANTY INFORMATION

3.1 WARRANTY INFORMATION AND REGISTRATION

3.1.1 WARRANTY INFORMATION

This product is guaranteed to be free from manufacturing defects in material and workmanship under normal use for a period of three (3) years from the date of purchase. In the event that a defect covered by the below warranty occurs during the applicable period stated above, AGM Global Vision, at its discretion, will either repair or replace the product; such action on the part of AGM Global Vision shall be the full extent of AGM Global Vision's liability, and the Customer's sole and exclusive reparation. This warranty does not cover a product if it has been (a) used in ways other than its normal and customary manner; (b) subjected to misuse; (c) subjected to alterations, modifications or repairs by the Customer or by any party other than AGM Global Vision without prior written consent of AGM Global Vision; (d) is the result of a special order or categorized as "close-out" merchandise or merchandise sold "as-is" by either AGM Global Vision or the AGM Global Vision dealer; or (e) merchandise that has been discontinued by the manufacturer and either parts or replacement units are not available due to reasons beyond the control of AGM Global Vision. AGM Global Vision shall not be responsible for any defects or damage that in AGM Global Vision's view are a result from the mishandling, abuse, misuse, improper storage or improper operation of the device, including use in conjunction with equipment that is electrically or mechanically incompatible with, or of inferior quality to, the product, as well as failure to maintain the environmental conditions specified by the manufacturer. This warranty is extended only to the original purchaser. Any breach of this warranty shall be enforced unless the customer notifies AGM Global Vision at the address noted below within the applicable warranty period.

The customer understands and agrees that except for the foregoing warranty, no other warranties written or oral, statutory, expressed or implied, including any implied warranty of merchantability or fitness for a particular purpose, shall apply to the product. All such implied warranties are hereby and expressly disclaimed.

3.1.2 LIMITATION OF LIABILITY

AGM Global Vision will not be liable for any claims, actions, suits, proceedings, costs, expenses, damages, or liabilities arising out of the use of this product. Operation and use of the product are the sole responsibility of the Customer. AGM Global Vision's sole undertaking is limited to providing the products and services outlined herein in accordance with the terms and conditions of this Agreement. The provision of products sold and services performed by AGM Global Vision to the Customer shall not be interpreted, construed, or regarded, either expressly or implied, as being for the benefit of or creating any obligation toward any third party of legal entity outside AGM Global Vision and the Customer; AGM Global Vision's obligations under this Agreement extend solely to the Customer. AGM Global Vision's

liability hereunder for damages, regardless of the form or action, shall not exceed the fees or other charges paid to AGM Global Vision by the customer or customer's dealer. AGM Global Vision shall not, in any event, be liable for special, indirect, incidental, or consequential damages, including, but not limited to, lost income, lost revenue, or lost profit, whether such damages were foreseeable or not at the time of purchase, and whether or not such damages arise out of a breach of warranty, a breach of agreement, negligence, strict liability, or any other theory of liability.

3.1.3 PRODUCT REGISTRATION

In order to validate the warranty on your product, the customer must complete and submit AGM Global Vision PRODUCT REGISTRATION FORM on our website (www.agmglobalvision.com/customer-support).

3.1.4 OBTAINING WARRANTY SERVICE

To obtain warranty service on your unit, the End-user (Customer) must notify the AGM Global Vision service department via e-mail. Send any requests to support@agmglobalvision.com to receive a Return Merchandise Authorization number (RMA). When returning any device, please take the product to your retailer, or send the product, postage paid and with a copy of your sales receipt, to AGM Global Vision's service center at the address listed above. All merchandise must be fully insured with the correct postage; AGM Global Vision will not be responsible for improper postage or merchandise that becomes lost or damaged during shipment. When sending product back, please clearly write the RMA# on the outside of the shipping box. Please include a letter that indicates your RMA#, the Customer's Name, a Return Address, reason for the return, contact information (valid telephone numbers and/or an e-mail address), and proof of purchase that will help us to establish the valid start date of the warranty. Product merchandise returns that do not have an RMA# listed may be refused, or a significant delay in processing may occur. Estimated Warranty service time is 10-20 business days. The End-user/Customer is responsible for postage to AGM Global Vision for warranty service. AGM Global Vision will cover return postage/shipping after warranty repair to the End-user/Customer only if the product is covered by the aforementioned warranty. AGM Global Vision will return the product after warranty service by domestic UPS Ground service and/or domestic mail. Should any other requested, required, or international shipping methods be necessary, the postage/shipping fee will be the responsibility of the End-user/Customer.

For service, repair or replacement, please contact:

AGM Global Vision
173 West Main Street
PO Box 962
Springerville, AZ 85938
Tel. 928.333.4300
Fax 480.393.4882
support@agmglobalvision.com
www.agmglobalvision.com

4 SPECIFICATIONS

4.1 SPECIFICATIONS

The following tables provide information pertaining to the operational, electrical, mechanical, optical, and environmental characteristics of the goggles.

TABLE 4-1. SPECIFICATIONS

	PYTHON-MICRO TS35	PYTHON-MICRO TS50	PYTHON-MICRO TS50LRF
Microbolometer			
Type	Uncooled	Uncooled	Uncooled
Resolution	384×288	384×288	384×288
Frame Rate	50 Hz	50 Hz	50 Hz
Pixel Size	17 um	17 um	17 um
Optical Characteristics			
Objective Lens	35mm, F/1.1	50mm, F/1.1	50mm, F/1.1
Magnification	1.9x	2.7x	2.7x
Zoom	2x/4x/PIP(2x)	2x/4x/PIP(2x)	2x/4x/PIP(2x)
Eye Relief	60 mm	60 mm	60 mm
Dioptr Adjustment	-5 to +4	-5 to +4	-5 to +4
FOV	10.6° × 8.0°	7.4° × 5.6°	7.4° × 5.6°
Close-up Range	5 m	5 m	5 m
Display			
Type	OLED	OLED	OLED
Resolution	1024×768	1024×768	1024×768
Detection Range (1.7m target)	1350 m	1800 m	1800 m
Recognition Range (1.7m)	450 m	600 m	600 m
Detection Range (2.3m target)	1800 m	2400 m	2400 m
Recognition Range (2.3m)	600 m	800 m	800 m

Power Supply			
Battery Type	2 x CR123	2 x CR123	2 x CR123
External Power Supply	5 V USB	5 V USB	5 V USB
Battery Life (Operating, 20°C)	5 hrs	5 hrs	5 hrs
Laser Range finder			
Laser Range finder	-	-	Yes
Measurement	-	-	5~600 m
Accuracy	-	-	0.5 m
Laser	-	-	Class 1; 905 nm; 1 mW; Eye safe
Physical Parameters			
Degree of Protection	IP66	IP66	
Operation Temperature	-25°C to +50°C	-25°C to +50°C	-25°C to +50°C
Storage Temperature	-40°C to +60°C	-40°C to +60°C	-40°C to +60°C
Shock and Vibration	1200 g/ms	1200 g/ms	1200 g/ms
MTBF	More than 800 hrs	More than 800 hrs	More than 800 hrs
Weight (w/o batteries)	0.38 kg (0.83 lbs)	0.41 kg (0.90 lbs)	0.51 kg (1.12 lbs)
Dimension	176×61×67 mm (6.9×2.4×2.6 in)	193×65×67 mm (7.5×2.5×2.6 in)	193×100×67 mm (7.5×3.9×2.6 in)



AGM Global Vision

MAIN OFFICE

173 West Main Street

PO Box 962

Springerville, AZ 85938

USA

Tel. +1.928.333.4300

Fax +1.480.393.4882

info@agmglobalvision.com

www.agmglobalvision.com

EUROPEAN OFFICE

Andrey Lyapchev #7

Sofia, P.C. 1756

Bulgaria

Tel. +44.292.255.0509

info@agmglobalvision.eu

www.agmglobalvision.eu

AGMglobalvision.com